



Engineered. Excellence. Delivered.



BARTOS

DALLAS/FT. WORTH WAREHOUSE CATALOG

Fall 2022



bartosindustries.com | Engineered. Excellence. Delivered.

Dallas

10350 Olympic Dr.
Dallas, Texas 75220
214-350-6871
469-759-2918 fax



BARTOS

www.bartosindustries.com

Fort Worth

2901 Wesley Way
Fort Worth, TX
682-253-0122
682-253-0135 fax



www.aaf-filters.com
Air Filtration Products
Industrial Air Handling Units



www.absolutaire.com
Direct Fired & Specialty Air Handling Units



www.accurex.com
Complete Kitchen Ventilation Solutions



www.aermec.us
Chillers and Fan Coils



air conditioning for every environment
www.airedaleusa.com
Indoor Packaged A/C & Heat Pump Systems



www.badgermeter.com
Flow Instrumentation



www.car-mon.com
Vehicle Exhaust Capturing Systems
Welding Fume Exhaust Systems



Advanced Technology for Indoor Air Quality
www.cosatron.com
Electronic Air Purification Systems



www.dcahumidifier.com
Commercial & Industrial Dehumidification Systems
100% Outside Air Split DX Systems



www.denlarhoods.com
Commercial Kitchen Hood for Residential Appliances



www.dristeam.com
Humidification Productions



www.ductsox.com
Textile Air Dispersion Products



www.ebtron.com
High Performance Airflow Measurement Devices



<http://www.fujitsu-general.com/>
High quality ductless products, VRF systems, and the best technical support in the industry



www.greenheck.com
Fans, Louvers & dampers, Kitchen Hoods, Pollution Control Units, Make-Up Air Units, Energy Recovery Systems, Outdoor Air Systems, Laboratory Exhaust Systems



www.greentrol.com
Airflow Stations for Packaged Rooftop Units



www.hayvalvecontrols.com
Automatic & Manual Balancing Valve Packages



www.honeywellanalytics.com
Commercial & Industrial Gas Detection System



www.indeco.com
Industrial & Commercial Electric Heating Products



www.kineticsnoise.com
Vibration Isolation & Seismic Restraint Products
Architectural & Structural Noise Control



www.macroair.com
High Volume Low Speed Circulation Fans



www.magicair.com
Unit Ventilators, Fan Coil Units



<http://www.aibocel.com/marvair>
Heating, Ventilating, and Air Conditioning Units



www.matairtech.com
Remote Cable Operated Dampers



www.metalaires.com
Commercial Grilles, Registers, & Diffusers
Fan Powered & VAV Air Terminal Units



www.movexinc.com
Local Extractors, Exhaust Extractors



www.pottorff.com/categories/01-69
HVAC Duct Silencers, Acoustical Panels, Enclosures, & Acoustical Louvers



www.poweredair.com
Industrial & Commercial Air Curtains



www.procoproducts.com
Flexible Pipe Connectors
Pipe Penetration Seals



www.robertsgordon.com
Gas Fired Infrared Heating Systems
Maker of the High Efficiency "Co-Ray-va" Infrared Heating System



<http://www.rpsurbs.com/>
Prefabricated Rooftop Products for Commercial Roofing



www.seasons4.net
Custom HVAC Systems



www.smartd.com/NA-EN/index.html
High Efficiency Oil-Free Centrifugal Chillers



www.trioninc.com
Industrial Air Cleaners
Kitchen Exhaust Electrostatic Precipitators
Dust Collectors

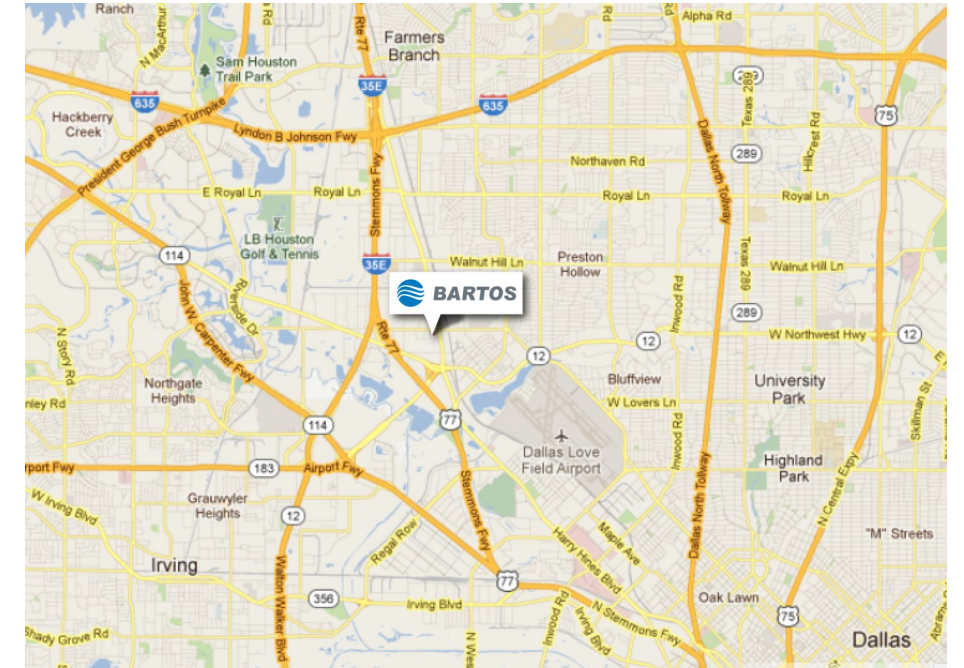

DALLAS

10350 Olympic Drive
Dallas, TX 75220

Phone: 214. 350. 6871

Fax: 214. 350. 8481

Hours Monday- Friday

7:30 AM-4:30 PM

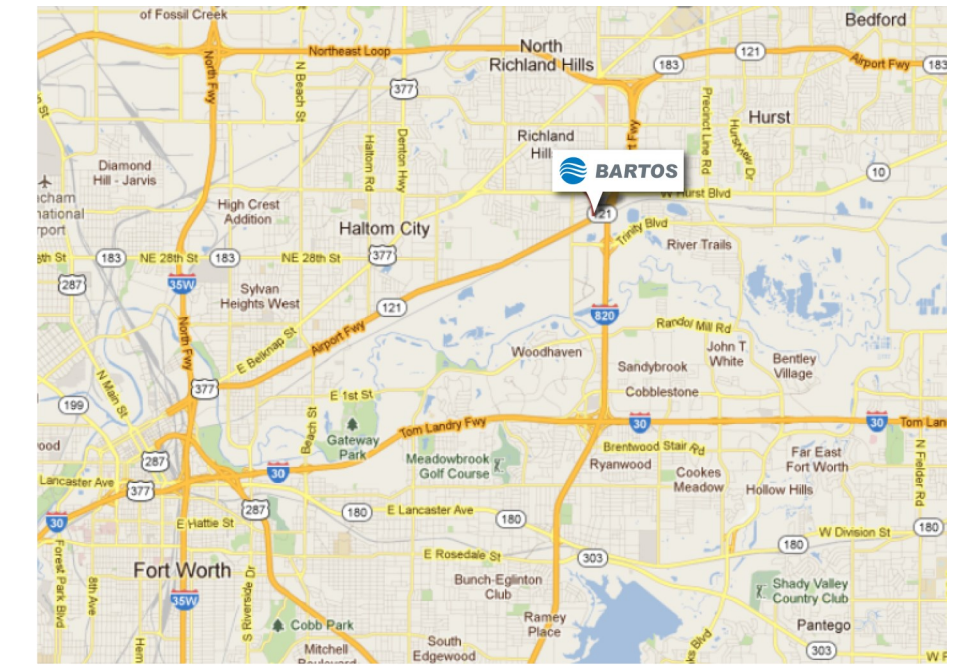

FORT WORTH

2901 Wesley Way
Fort Worth, TX 76118

Phone: 682. 253. 0122

Fax: 682. 253. 01351

Hours Monday- Friday

7:30 AM-4:30 PM



Suspended Spring Hangers



KNCSH

KNCSRH

| Suspended Spring Hangers | | | |
|--------------------------|----------------------|------------|--------------------|
| Model | Type | Deflection | Capacity |
| KNCSH (Capacity) | Spring Hanger | 1" | 35 lbs - 1,700 lbs |
| KNCSRH (Capacity) | Spring/Rubber Hanger | 1" | 35 lbs - 1,700 lbs |

Housed Springs Floor Isolator

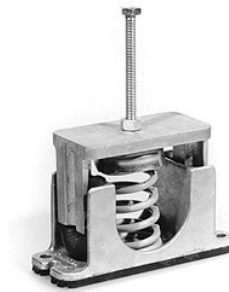

| Restrained Floor Housing | | | |
|--------------------------|-------------------|------------|------------------|
| Model | Type | Deflection | Capacity |
| KNCSL (Capacity) | Restrained Spring | 1" | 35 lbs - 370 lbs |

Open Spring Floor Isolator



| Open Spring Floor Housing | | | |
|---------------------------|-------------|------------|--------------------|
| Model | Type | Deflection | Capacity |
| KNCFDS (Capacity) | Open Spring | 1" | 35 lbs - 1,700 lbs |

Neoprene Pads



KNCNPD



KNCRSP

| Neoprene Pads | | | |
|---------------|--------|------------|-------------------------|
| Model | Type | Deflection | Capacity |
| KNCNPD | Ribbed | .09" | 60 lbs/ Square Inch Max |
| KNCRSP | Waffle | .15" | 60 lbs/ Square Inch Max |

DALLAS
 10350 Olympic Drive
 Dallas, TX 75220
 800.539.4633 Toll Free
 214.350.6871 Main Line

FORT WORTH
 2901 Wesley Way
 Fort Worth, TX 76118
 800.858.8497 Toll Free
 682.253.0122 Main Line

Table of Content

| Description | Page |
|---------------------------|-------|
| Air Devices | 4-15 |
| Air Device Accessories | 16-18 |
| Dampers | 18-22 |
| Ventilation Products | 22-24 |
| Terminal Units | 25 |
| Ductless Mini-Splits | 26 |
| Heating Products | 27 |
| Filtration Products | 28 |
| Gas Detection | 28 |
| Variable Frequency Drives | 29 |
| Vibration Isolation | 30 |

Terms of Sale

Terms of Sale are Net 30 Days, F.O.B. shipping point or as printed on invoice.

Bartos Industries will not accept any material returned without prior permission. Material returned for credit is subject to a restocking charge. Please consult your Bartos representative and obtain written authorization before returning materials to our facility. Unauthorized returns will not be subject to issuance of credit.

All invoices are payable in Dallas, Dallas County, Texas at an office of Bartos Industries and customer agrees to make all payments at said place in accordance with these terms.

Pricing and/or dimensional data contained herein is subject to change without notice.

Freight Claims: We at Bartos are responsible for suitably transferring our materials to the carrier in good condition. It is the receiver's responsibility to inventory the materials received versus those listed on the packing list, and make note of any damage which may have occurred during transport, and to document shortages on the carrier's bill of lading. Freight claims shall be filed by the receiver against the transportation company/carrier.

Warranty for materials shipped are the manufacturer's standard one year (from the date of shipment-unless otherwise indicated), parts only. Materials for unpaid invoices will not be subject to warranty coverage.

BARTOS STOCK PROGRAM & EXPIDITED ORDER CLARIFICATIONS:

All dimensions indicated in this documents are in normal inches unless noted otherwise, and are subject to changes without notice. Please refer to the manufacturer's submittal data on their respective websites for the latest dimensional and/or performance characteristics.

All Pricing is subject to change without notice. Freight and material costs frequently fluctuate without notice. Please contact your Bartos representative for current pricing

Factory orders which are expeditated are **NOT SUBJECT TO CHANGE OR CANCELLATION.**

5700/5700-AL- Fixed Square 2-Cone Diffuser



Fixed 2-Cone pattern controller
Steel Construction (5700) & Aluminum Construction (5700-AL)
Lay-in border 6

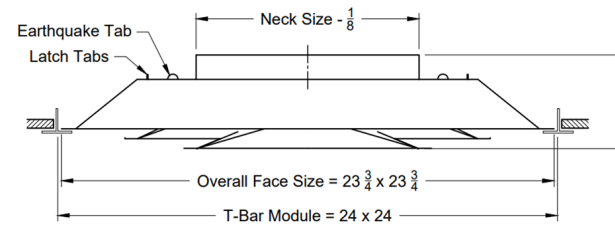
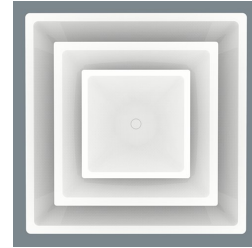

| Cross Reference | |
|-----------------|-------|
| Brand | Model |
| Titus | TMS |
| Price | SCD |
| Nailor | RNS2 |
| Krueger | 1450 |

Accessories

- TBPF-Trim frames
- BDS-Steel butterfly dampers
- RDS- Steel radial dampers
- BAF- Sectorizing Baffles
- FGBP- Fiberglass Backpan
- SNAP 58-Optional 3rd cone

| 5700-Fixed Steel Construction | | |
|-------------------------------|------|-----------|
| Model Number | Neck | Face |
| GHXG57006 06/12 01 | 6" | 12" x 12" |
| GHXG57006 08/12 01 | 8" | 12" x 12" |
| TBS1200082020 | 8" | 20" x 20" |
| TBS1200102020 | 10" | 20" x 20" |
| GHXG57006 06/24 01 | 6" | 24" x 24" |
| GHXG57006 08/24 01 | 8" | 24" x 24" |
| GHXG57006 10/24 01 | 10" | 24" x 24" |
| GHXG57006 12/24 01 | 12" | 24" x 24" |
| GHXG57006 14/24 | 14" | 24" x 24" |

| 5700AL-Fixed Aluminum Construction | | |
|------------------------------------|------|-----------|
| Model Number | Neck | Face |
| GHXG57006 AL 06/12 01 | 6" | 12" x 12" |
| GHXG57006 AL 08/12 01 | 8" | 12" x 12" |
| GHXG57006 AL 06/24 01 | 6" | 24" x 24" |
| GHXG57006 AL 08/24 01 | 8" | 24" x 24" |
| GHXG57006 AL 10/24 01 | 10" | 24" x 24" |
| GHXG57006 AL 12/24 01 | 12" | 24" x 24" |
| GHXG57006 AL 14/24 C | 14" | 24" x 24" |

5700A-Adjustable 2-Cone Diffuser



Adjustable Pattern Controller
Steel Construction
Lay-in border 6
White Finish

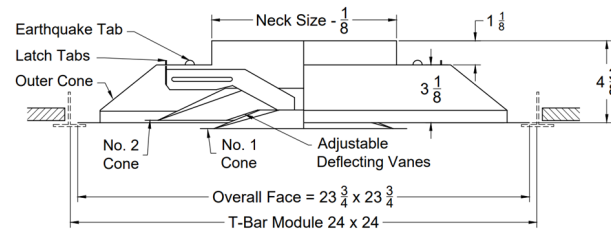
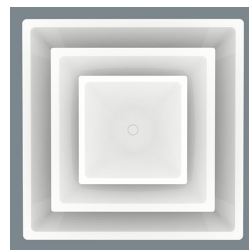

| 5700A-Adjustable | | |
|---------------------|------|-----------|
| Model Number | Neck | Face |
| GHXG5700A6 06/24 01 | 6" | 24" x 24" |
| GHXG5700A6 08/24 01 | 8" | 24" x 24" |
| GHXG5700A6 10/24 01 | 10" | 24" x 24" |
| GHXG5700A6 12/24 01 | 12" | 24" x 24" |
| GHXG5700A6 14/24 01 | 14" | 24" x 24" |

| Cross Reference | |
|-----------------|-------|
| Brand | Model |
| Titus | TMSA |
| Price | SCDA |
| Nailor | RNSA |
| Krueger | 1450A |

Accessories

- TBPF-Trim frames
- BDS-Steel butterfly dampers
- RDS- Steel radial dampers
- BAF- Sectorizing Baffles
- FGBP- Fiberglass Backpan
- SNAP 58-Optional 3rd cone

DALLAS
10350 Olympic Drive
Dallas, TX 75220
800.539.4633 Toll Free
214.350.6871 Main Line

FORT WORTH
2901 Wesley Way
Fort Worth, TX 76118
800.858.8497 Toll Free
682.253.0122 Main Line



P-Drive -Variable Frequency Drive

| P-DRIVE VFDs | | | |
|--------------|-----|---------|-------|
| Model | HP | VOLTAGE | PHASE |
| FC7HP460V | 7.5 | 460V | 3 PH |
| FC25HP460V | 25 | 460V | 3 PH |
| FC7HP230V | 7 | 230V | 3 PH |
| FC10HP230V | 10 | 230V | 3 PH |
| FC15HP230V | 15 | 230V | 3 PH |
| FC20HP230V | 20 | 230V | 3 PH |
| FC25HP230V | 25 | 230V | 3 PH |



Q-Link -VFD Technology

The Q-link Variable Frequency Drive provides a revolutionary user experience through its intuitive iOS and Android smartphone apps. The Q-link connects to your smartphone via Bluetooth® and allows for guided start-up, automated reports, in-app support, and more. It provides an array of inputs and outputs including damper control. Native communications include BACnet and Modbus. The Q-link uses R³ Filtering – a sophisticated filtering algorithm – to reduce harmonic distortion and provide equivalent performance to an AC line reactor, without the added cost.



Q-Link -Multi Phase -Variable Frequency Drive w/Bypass

| Q-Link With Bypass Multi-Phase VFD's | | | | |
|--------------------------------------|-----|---------|------|---------|
| Model | HP | Voltage | HP | Voltage |
| FCSQLNKBY3480 | 3 | 480V | 1.5 | 230V |
| FCSQLNKBY5480 | 5 | 480V | 2.5 | 230V |
| FCSQLNKBY75480 | 7.5 | 480V | 3.75 | 230V |
| FCSQLNKBY10480 | 10 | 480V | 5 | 230V |
| FCSQLNKBY15480 | 15 | 480V | 7.5 | 230V |
| FCSQLNKBY20480 | 20 | 480V | 10 | 230V |



Q-Link -Stand Alone-Variable Frequency Drive

| Stand-Alone Q-Link | | |
|--------------------|-------------|---------|
| Model | HP | Voltage |
| FCSQLNK5480 | 1 THRU 5 | 480V |
| FCSQLNK10480 | 7.5 THRU 10 | 480V |
| FCSQLNK15480 | 15 | 480V |
| FCSQLNK20480 | 20 | 480V |



DALLAS
10350 Olympic Drive
Dallas, TX 75220
800.539.4633 Toll Free
214.350.6871 Main Line

FORT WORTH
2901 Wesley Way
Fort Worth, TX 76118
800.858.8497 Toll Free
682.253.0122 Main Line



MERV 9-Filter Media Rolls



| FILP-Filter Media Rolls | | | |
|-------------------------|----------------|----------------|--------------|
| Model | Type | Air resistance | Color |
| PAPOBL2 | 2" Roll Filter | 84% | Blue/White |
| PAPOOR1 | 1" Roll Filter | 90% | Orange/White |



MERV 10-Pleated Filters

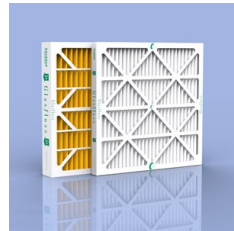

| MERV 10 - Pleated Filters | | |
|---------------------------|---------|-------|
| Model | Size | Depth |
| PLEAT11224 | 12"x24" | 1" |
| PLEAT11420 | 14"x20" | 1" |
| PLEAT11425 | 14"x25" | 1" |
| PLEAT11520 | 15"x20" | 1" |
| PLEAT11620 | 16"x20" | 1" |
| PLEAT11625 | 16"x25" | 1" |
| PLEAT12020 | 20"x20" | 1" |
| PLEAT12024 | 20"x24" | 1" |
| PLEAT12025 | 20"x25" | 1" |
| PLEAT12424 | 24"x24" | 1" |
| PLEAT12525 | 25"x25" | 1" |
| PLEAT21020 | 10"x20" | 2" |
| PLEAT21220 | 12"x20" | 2" |
| PLEAT21224 | 12"x24" | 2" |
| PLEAT21420 | 14"x20" | 2" |
| PLEAT21425 | 14"x25" | 2" |
| PLEAT21520 | 15"x20" | 2" |

| MERV 10 - Pleated Filters | | |
|---------------------------|---------|-------|
| Model | Size | Depth |
| PLEAT21620 | 16"x20" | 2" |
| PLEAT21624 | 16"x24" | 2" |
| PLEAT21625 | 16"x25" | 2" |
| PLEAT21824 | 18"x24" | 2" |
| PLEAT22020 | 20"x20" | 2" |
| PLEAT22024 | 20"x24" | 2" |
| PLEAT22025 | 20"x25" | 2" |
| PLEAT22424 | 24"x24" | 2" |
| PLEAT41224 | 12"x24" | 4" |
| PLEAT41620 | 16"x20" | 4" |
| PLEAT41625 | 16"x25" | 4" |
| PLEAT41824 | 18"x24" | 4" |
| PLEAT42020 | 20"x20" | 4" |
| PLEAT42024 | 20"x24" | 4" |
| PLEAT42025 | 20"x25" | 4" |
| PLEAT42424 | 24"x24" | 4" |
| PLEAT42529 | 25"x29" | 4" |



Honeywell Gas Detection

- Standalone, standalone with remote (dual gas mode) or network versions available
- Saves energy through Demand Control Ventilation
- Advanced sensing technology detects CO, NO₂, O₂, H₂, H₂S, CH₄, C₃H₈

| Honeywell Controls | |
|--------------------|------------------------------|
| Model | Description |
| HWE3SAH | E3 120V Stand Alone Sensor |
| HWE3SM | E3 Gas Monitor Point Network |
| HWVA301C | 301C Plastic Control Panel |



E3 Gas Monitor Point Network



HWE3SAH-Stand Alone Sensor

DALLAS
10350 Olympic Drive
Dallas, TX 75220
800.539.4633 Toll Free
214.350.6871 Main Line

FORT WORTH
2901 Wesley Way
Fort Worth, TX 76118
800.858.8497 Toll Free
682.253.0122 Main Line



5750-Square Panel Face Diffuser

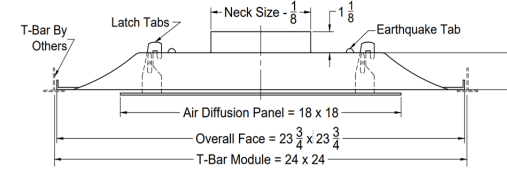

Panel Face Pattern Controller
Steel Construction
Lay-in border 6
White Finish

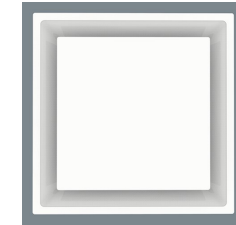

| 5750-Panel Face-Steel Construction | | |
|------------------------------------|------|-----------|
| Model Number | Neck | Face |
| GHXG57506 06/12 01 | 6" | 12" x 12" |
| GHXG57506 08/12 01 | 8" | 12" x 12" |
| GHXG57506 06/24 01 | 6" | 24" x 24" |
| GHXG57506 08/24 01 | 8" | 24" x 24" |
| GHXG57506 10/24 01 | 10" | 24" x 24" |
| GHXG57506 12/24 01 | 12" | 24" x 24" |
| GHXG57506 14/24 0 | 14" | 24" x 24" |

| Cross Reference | |
|-----------------|-------|
| Brand | Model |
| Titus | OMNI |
| Price | SPD |
| Nailor | ASPD |
| Krueger | UNI |

| 5750-Panel Face-Aluminum Construction | | |
|---------------------------------------|------|-----------|
| Model Number | Neck | Face |
| GHXG57506 AL 06/12 01 | 6" | 12" x 12" |
| GHXG57506 AL 06/24 01 | 6" | 24" x 24" |
| GHXG57506 AL 08/24 01 | 8" | 24" x 24" |
| GHXG57506 AL10/24 01 | 10" | 24" x 24" |
| GHXG57506 AL 12/24 01 | 12" | 24" x 24" |
| GHXG57506 AL 14/24 01 | 14" | 24" x 24" |

- Accessories**
- TBPF-Trim frames
 - BDS-Steel butterfly dampers
 - RDS- Steel radial dampers
 - BAF- Sectorizing Baffles
 - FGBP- Fiberglass backpan
 - BO1- Blank-off Panel

3100- Fixed Round 2- Cone Diffuser

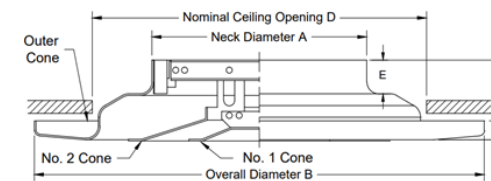

Flush Face Fixed Pattern Controller
Aluminum Construction
White Finish

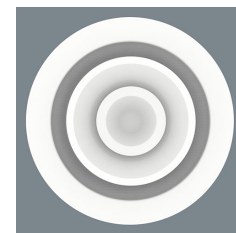

| 3100- Fixed 2-Cone | | | | | | | |
|---------------------|------|--------|--------|-------|----|---|-----|
| DIMENSIONS (Inches) | | | | | | | |
| Model | Size | A | B | C | D | E | F |
| GHXG310010 | 10 | 9 3/4 | 21 3/4 | 3 1/4 | 17 | 1 | 3/4 |
| GHXG310012 | 12 | 11 3/4 | 21 7/8 | 3 1/4 | 17 | 1 | 3/4 |

| Cross Reference | |
|-----------------|-------|
| Brand | Model |
| Titus | TMR |
| Price | RCD |

- Accessories**
- BDS- Steel butterfly dampers
 - RDS- Steel radial dampers

3100SA- Adjustable Round 2- Cone Diffuser

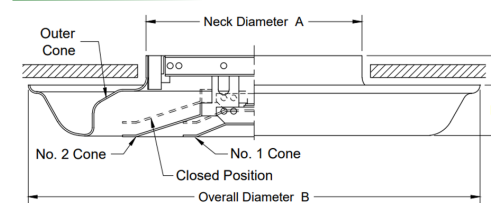

Drop Face Adjustable Pattern Controller
Steel Construction
White Finish



| Dimensions (Inches) | | | | | |
|---------------------|------|--------|--------|-------|-------|
| Model | Size | A | B | C | H |
| GHXG3100SA2 06 01 | 6 | 5 3/4 | 16 1/8 | 3 | 2 1/4 |
| GHXG3100SA2 08 01 | 8 | 7 3/4 | 16 1/8 | 3 | 2 1/4 |
| GHXG3100SA2 10 01 | 10 | 9 3/4 | 21 3/8 | 3 1/4 | 2 3/4 |
| GHXG3100SA2 12 01 | 12 | 11 3/4 | 21 3/8 | 3 1/4 | 2 3/4 |
| GHXG3100SA2 14 0 | 14 | 13 3/4 | 28 3/4 | 4 | 3 1/2 |

| Cross Reference | |
|-----------------|-------|
| Brand | Model |
| Titus | TMRA |
| Price | RCDA |

- Accessories**
- BDS- Steel butterfly dampers
 - RDS- Steel radial dampers

DALLAS
10350 Olympic Drive
Dallas, TX 75220
800.539.4633 Toll Free
214.350.6871 Main Line

FORT WORTH
2901 Wesley Way
Fort Worth, TX 76118
800.858.8497 Toll Free
682.253.0122 Main Line



5500S/5500-Square Directional Diffuser- Lay-in

Steel Construction (5500S) & Aluminum Construction (5500)
Lay-in border 6
White Finish



| 5500- Aluminum-Lay-in Border 6 | | | |
|--------------------------------|-----------|-----------|--------------|
| Model Number | Neck Size | Face Size | Throw |
| GHXG55006 06x06/24S401 | 06" x 06" | 24" x 24" | 4-Way |
| GHXG55006 09x09/24S401 | 09" x 09" | 24" x 24" | 4-Way |
| GHXG55006 12x12/24S401 | 12" x 12" | 24" x 24" | 4-Way |
| GHXG55006 15x15/24S401 | 15" x 15" | 24" x 24" | 4-Way |
| GHXG55006 18x18/24S401 | 18" x 18" | 24" x 24" | 4-Way |
| GHXG55006 12x12/24S201 | 12" x 12" | 24" x 24" | 2-Way |
| GHXG55006 12x12/24S301 | 12" x 12" | 24" x 24" | 3-Way |
| GHXG55006 12x12/24SC01 | 12" x 12" | 24" x 24" | 2-Way Corner |
| GHXG55006 15x15/24S201 | 15" x 15" | 24" x 24" | 2-Way |
| GHXG55006 15x15/24S301 | 15" x 15" | 24" x 24" | 3-Way |
| GHXG55006 15x15/24SC01 | 15" x 15" | 24" x 24" | 2-Way Corner |
| GHXG55006 18x18/24S201 | 18" x 18" | 24" x 24" | 2-Way |
| GHXG55006 18x18/24S301 | 18" x 18" | 24" x 24" | 3-Way |
| GHXG55006 18x18/24SC01 | 18" x 18" | 24" x 24" | 2-Way Corner |

Model: 5500-6 (Lay in T-Bar)

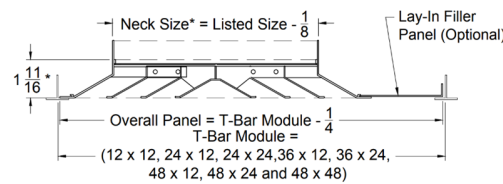

* Filler panel included for neck sizes under 18 x 18 to fit in 24 x 23, 24 x 24 T-bar grid, (6 x 6, 9 x 9, 12 x 12 and 15 x 15 include filler panel).



5500S/5500-Directional Diffuser- Surface Mounted

Steel Construction (5500S) & Aluminum Construction (5500)
Surface Mounted border 1
White Finish



Model: 5500-1 (Flush Surface Mounting)

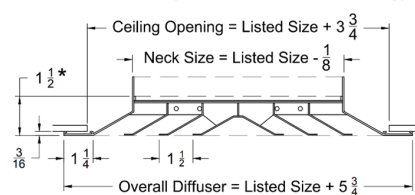

| 5500S-Steel-Surface Mount Border 1 | | |
|------------------------------------|-----------|-------------------|
| Model Number | Neck | Face |
| GHXG5500S1 06x06 S4 01 | 06" x 06" | 11-5/8" x 11-5/8" |
| GHXG5500S1 09x09 S4 01 | 09" x 09" | 14-5/8" x 14-5/8" |
| GHXG5500S1 12x12 S4 01 | 12" x 12" | 17-5/8" x 17-5/8" |
| GHXG5500S1 15x15 S4 01 | 15" x 15" | 20-5/8" x 20-5/8" |

| 5500-Aluminum- Surface Mount Border 1 | | |
|---------------------------------------|-----------|-------------------|
| Model Number | Neck | Face |
| GHXG55001 06x06 S4 01 | 06" x 06" | 11-5/8" x 11-5/8" |
| GHXG55001 09x09 S4 01 | 09" x 09" | 14-5/8" x 14-5/8" |
| GHXG55001 12x12 S4 01 | 12" x 12" | 17-5/8" x 17-5/8" |
| GHXG55001 15x15 S4 01 | 15" x 15" | 20-5/8" x 20-5/8" |

| Cross Reference | | |
|-----------------|-------|----------|
| Brand | Steel | Aluminum |
| Titus | TDC | TDC-AA |
| Price | SMD | AMD |
| Nailor | 6500 | 6200 |
| Krueger | SH | 5SHR |

Accessories
TBPF- Trim Frames
D5A-Aluminum Opposed blade dampers
DMSR- Square to round Adapters
FGBP- Fiberglass backpan (24" x 24" only)

DALLAS
10350 Olympic Drive
Dallas, TX 75220
800.539.4633 Toll Free
214.350.6871 Main Line

FORT WORTH
2901 Wesley Way
Fort Worth, TX 76118
800.858.8497 Toll Free
682.253.0122 Main Line



Powered Vented Gas Unit Heater

| Vertical Power Vented | | | |
|-----------------------|---------------|-------------|----------------|
| Model | BTUH Input | BTUH Output | Vent Pipe Size |
| MOPDP150AE130 | 150,000 | 123,000 | 05" |
| MOPDP200AE130 | 200,000 | 164,000 | 05" |
| MOPDP250AE130 | 250,000 | 205,000 | 06" |
| MOPDP400AE130 | 400,000 | 328,000 | 06" |
| MOSTATSH | 2 Pole T-Stat | | |



Electric Unit Heater

| UHI-Electric Unit Heater | | | |
|--------------------------|------------------|------------|---------------------|
| Model | KW | Voltage/PH | Accessories |
| INUHIR332081DT | 3.3 | 208V/1 PH | Disconnect & T-stat |
| INUHIR502081DT | 5 | 208V/1 PH | Disconnect & T-stat |
| INUHIR382083DT | 3.8 | 208V/3 PH | Disconnect & T-stat |
| INUHIR502083DT | 5 | 208V/3 PH | Disconnect & T-stat |
| INUHIR752083DT | 7.5 | 208v/3 PH | Disconnect & T-stat |
| INUHIR102083DT | 10 | 208V/3PH | Disconnect & T-stat |
| INUHIR332771DT | 3.3 | 277v/1 PH | Disconnect & T-stat |
| INUHIR502771DT | 5 | 277V/1 PH | Disconnect & T-stat |
| INUHIR374803DT | 3.7 | 480V/3 PH | Disconnect & T-stat |
| INUHIR754803DT | 7.5 | 480V/3 PH | Disconnect & T-stat |
| INUHIR104803DT | 10 | 480V/3 PH | Disconnect & T-stat |
| INUHIRBRACKET | Mounting Bracket | | |



Architectural Wall Heaters

| Architectural Wall Heater-Bronze | | | |
|----------------------------------|------------------------------|-----------|---------------------|
| Model | Watts | Voltage | Accessories |
| INWAI933U04000CBZD1 | 4,000 | 208V | Disconnect & T-stat |
| INWAI933U01500VBZD3 | 1,500/1,125 | 240V/208V | Disconnect & T-stat |
| INWAI933U02000VBZD3 | 2,000/1,500 | 240V/208V | Disconnect & T-stat |
| INWAI933U03000VBZD3 | 3,000/2,250 | 240V/208V | Disconnect & T-stat |
| INWAI933U04000VBZD1 | 4,000/3,000 | 240V/208V | Disconnect & T-stat |
| INWAI933U04800VBZD1 | 4,800/3,600 | 240V/208V | Disconnect & T-stat |
| INWAI933U02000NBZD3 | 2,000 | 277V | Disconnect & T-stat |
| INWAI933U03000NBZD3 | 3,000 | 277V | Disconnect & T-stat |
| INWAI933U04000NBZD3 | 4,000 | 277V | Disconnect & T-stat |
| INWAI933U04800NBZD3 | 4,800 | 277V | Disconnect & T-stat |
| INWAI933124501BZ | Surface Mounting Box- Bronze | | |



Commercial Heaters

| WCI-Commercial Wall Heaters-White | | | |
|-----------------------------------|----------------------------|-----------|---------------------|
| Model | Watts | Voltage | Accessories |
| INWCI932U04000VWD3 | 4,000/3,000 | 240V/208V | Disconnect & T-stat |
| INWCI932U04800VWD1 | 4,800/3,600 | 240V/208V | Disconnect & T-stat |
| INWCI932124500W | Surface Mounting Box-White | | |



| CCI-Commercial Ceiling Heaters-White | | | |
|--------------------------------------|----------------------------|-----------|---------------------|
| Model | Watts | Voltage | Accessories |
| INCCI931U04000NWD3T2 | 4,000 | 277V | Disconnect & T-stat |
| INCCI931U04000vWD3T2 | 4,000/3,000 | 240V/208V | Disconnect & T-stat |
| INCCI931124506W | Surface Mounting Box-White | | |
| INCCI931124512W | T-bar Adapter White | | |



Fan-Forced Wall Heaters

| WLI- Economy Wall Heater- White | | | |
|---------------------------------|----------------------------|-----------|---------------------|
| Model | Watts | Voltage | Accessories |
| INWLI934U01500BWDT5 | 1,500 | 120V | Disconnect & T-Stat |
| INWLI934U02000VWDT5 | 2,000/1,500 | 240V/208V | Disconnect & T-Stat |
| INWLI934124647W | Surface Mounting Box-White | | |



DALLAS
10350 Olympic Drive
Dallas, TX 75220
800.539.4633 Toll Free
214.350.6871 Main Line

FORT WORTH
2901 Wesley Way
Fort Worth, TX 76118
800.858.8497 Toll Free
682.253.0122 Main Line





Gree Commercial provides systems with the best in innovative technology to provide comfort to your office building, warehouse, storefront, hotel and more.



| PAN- Ductless Mini-Splits & Heat Pumps | | | | | | |
|--|---------|-----------|--------|-----|------|------|
| Model | Style | Voltage | BTU | TON | SEER | HPSF |
| GR12IU | Cooling | 208V-230V | 12,000 | 1 | 17 | 9 |
| GR12OU | Heating | | 13,000 | | | |
| GR18IU | Cooling | 208V-230V | 17,400 | 1.5 | 16 | 9 |
| GR18OU | Heating | | 18,000 | | | |
| GR24IU | Cooling | 208V-230V | 22,000 | 2 | 19 | 10 |
| GR24OU | Heating | | 24,000 | | | |
| GR36IU | Cooling | 208V-230V | 33,600 | 3 | 18 | 9 |
| GR36OU | Heating | | 34,600 | | | |

| Accessories | | | | | |
|-------------|--|-------|---------|-------|-------|
| Model | Description | 1 TON | 1.5 TON | 2 TON | 3 TON |
| SSPUMP | Aspen White Condensate Pump-Mini-White | X | X | X | |
| SSMINIORNG | 9-24 Internal Condensate Pump | X | X | X | |
| SSMAXIORNG | Internal Condensate Pump | | | | X |
| SSLS251824 | 18-24K 25' Line Set & Wiring | X | X | X | |
| SSLS501824 | 18-24K 50' Line Set & Wiring | X | X | X | |
| SSLS2536 | 36K 25' Line Set & Wiring | | | | X |
| SSLS2536 | 36K 50' Line Set & Wiring | | | | X |



Designer Remote

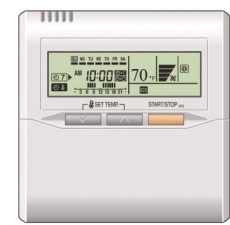

Optional Wired Thermostat Controller



Optional 25' or 50' Line Set



Condensate Pump

DALLAS
10350 Olympic Drive
Dallas, TX 75220
800.539.4633 Toll Free
214.350.6871 Main Line

FORT WORTH
2901 Wesley Way
Fort Worth, TX 76118
800.858.8497 Toll Free
682.253.0122 Main Line

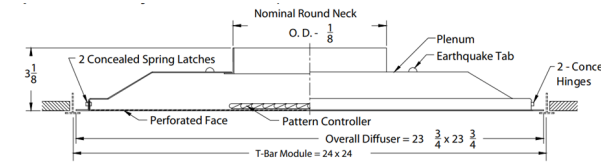

Steel Construction
Lay-in border 6
White Finish

| 7500-STEEL SUPPLY | | |
|--------------------|------|-----------|
| Model Number | Neck | Face |
| GHXG75006 06/12 01 | 06" | 12" x 12" |
| TBPP082020LT | 08" | 20" x 20" |
| TBPP102020LT | 10" | 20" x 20" |
| TBPP122020LT | 12" | 20" x 20" |
| GHXG75006 06/24 01 | 06" | 24" x 24" |
| GHXG75006 08/24 01 | 08" | 24" x 24" |
| GHXG75006 10/24 01 | 10" | 24" x 24" |
| GHXG75006 12/24 01 | 12" | 24" x 24" |
| GHXG75006 14/24 01 | 14" | 24" x 24" |

Accessories
TBPF-Trim frames
BDS-Steel butterfly dampers
RDS- Steel radial dampers
FGBP- Fiberglass backpan

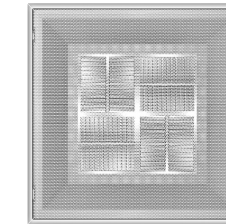

| Cross Reference | |
|-----------------|-------|
| Brand | Model |
| Titus | PAS |
| Price | PDF |
| Nailor | 4320 |
| Krueger | 6100 |

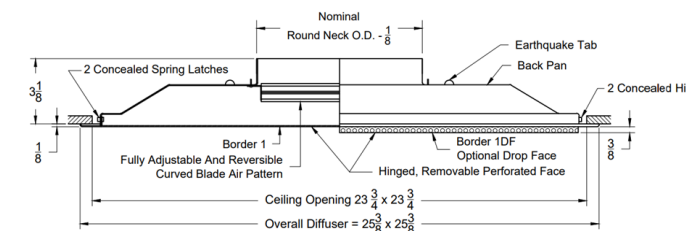

Steel Construction
Lay-in border 6
White Finish

| 7000-ALUMINUM SUPPLY | | |
|-----------------------|------|-----------|
| Model Number | Neck | Face |
| GHXG76006 08/24 4W 01 | 08" | 24" x 24" |
| GHXG6006 10/24 4W 01 | 10" | 24" x 24" |
| GHXG76006 12/24 4W 01 | 12" | 24" x 24" |
| GHXG76006 14/24 4W 01 | 14" | 24" x 24" |
| GHXG76006 16/24 4W 0 | 16" | 24" x 24" |

Accessories
TBPF-Trim frames
BDS-Steel butterfly dampers
RDS- Steel radial dampers
FGBP- Fiberglass backpan

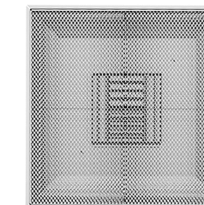

| Cross Reference | |
|-----------------|--------|
| Brand | Model |
| Titus | 7600 |
| Price | PDC |
| Nailor | 4320CB |
| Krueger | 6500 |

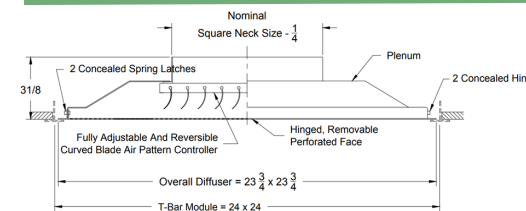

Aluminum Construction
Lay-in border 6
White Finish

| 7000-ALUMINUM SUPPLY | | |
|------------------------|-----------|-----------|
| Model Number | Neck | Face |
| GHXG70006 06x06/124W01 | 06" x 06" | 12" x 12" |
| GHXG70006 08x08/244W01 | 08" x 08" | 24" x 24" |
| GHXG70006 10x10/244W01 | 10" x 10" | 24" x 24" |
| GHXG70006 12x12/244W01 | 12" x 12" | 24" x 24" |
| GHXG70006 14x14/244W01 | 14" x 14" | 24" x 24" |

Accessories
TBPF-Trim frames
D5A- Aluminum opposed blade dampers
DMSR- Square to round adapters



| Cross Reference | |
|-----------------|--------|
| Brand | Model |
| Titus | PCS-AA |
| Price | PDCEF |
| Krueger | 51100 |

DALLAS
10350 Olympic Drive
Dallas, TX 75220
800.539.4633 Toll Free
214.350.6871 Main Line

FORT WORTH
2901 Wesley Way
Fort Worth, TX 76118
800.858.8497 Toll Free
682.253.0122 Main Line

PHPSI-High Performance Plenum Slot Diffuser



1" Slot Width (PHPSI-10), 1 1/2" Slot Width (PHPSI-15)
 Steel Construction Plenum/ Aluminum Pattern Controller
 1/2" Fiberglass insulation
 White Tees Black borders

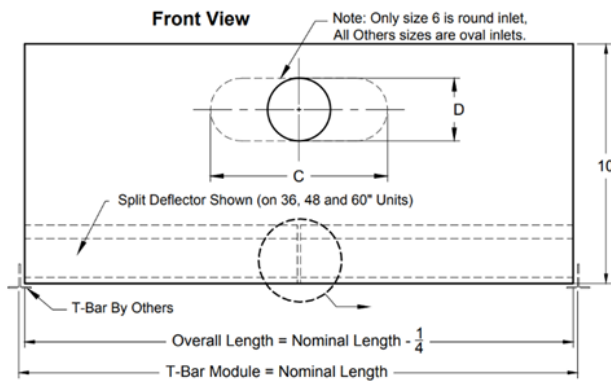
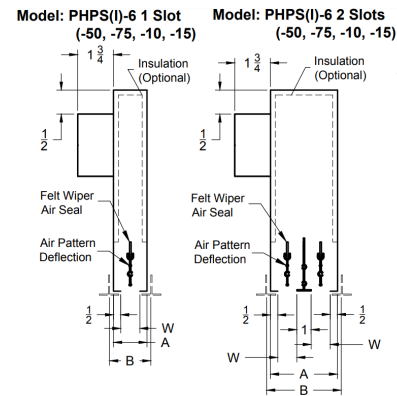

| Inlet Size | C | D |
|------------|----------|---------|
| 6 Round | - | 5 -7/8" |
| 8 Oval | 8-15/16" | 5-7/8" |
| 10 Oval | 12-1/16" | 5-7/8" |
| 12 Oval | 15-1/4" | 5-7/8" |

| Model | Lengths | W | 1 SLOT | | 2 SLOTS | |
|----------|----------|--------|--------|--------|---------|--------|
| | | | A | B | A | B |
| PHPSI-10 | 24", 48" | 1" | 2" | 2-1/4" | 4" | 4-1/4" |
| PHPSI-15 | 24", 48" | 1-1/2" | 2-1/2" | 2-3/4" | 5" | 5-1/4" |

| PHPSI-10 -1" SLOT | | | | | | |
|------------------------|--------|-------|-------|--|--|--|
| MODEL | LENGTH | SLOTS | INLET | | | |
| GHXGPHPSI 106 241 0625 | 24" | 1 | 06" | | | |
| GHXGPHPSI 106 241 0825 | 24" | 1 | 08" | | | |
| GHXGPHPSI 106 242 0825 | 24" | 2 | 08" | | | |
| GHXGPHPSI 106 481 0625 | 48" | 1 | 06" | | | |
| GHXGPHPSI 106 481 0825 | 48" | 1 | 08" | | | |
| GHXGPHPSI 106 481 1025 | 48" | 1 | 10" | | | |
| GHXGPHPSI 106 482 0825 | 48" | 2 | 08" | | | |
| GHXGPHPSI 106 482 1025 | 48" | 2 | 10" | | | |
| GHXGPHPSI 106 482 1225 | 48" | 2 | 12" | | | |

| PHPSI-15 -1 1/2" SLOT | | | | | | |
|-----------------------|--------|-------|-------|--|--|--|
| MODEL | LENGTH | SLOTS | INLET | | | |
| GHXGPHPSI 156 241 06 | 24" | 1 | 06" | | | |
| GHXGPHPSI 156 241 08 | 24" | 1 | 08" | | | |
| GHXGPHPSI 156 481 06 | 48" | 1 | 06" | | | |
| GHXGPHPSI 156 481 08 | 48" | 1 | 08" | | | |
| GHXGPHPSI 156 481 10 | 48" | 1 | 10" | | | |
| GHXGPHPSI 156 482 08 | 48" | 2 | 08" | | | |
| GHXGPHPSI 156 482 10 | 48" | 2 | 10" | | | |
| GHXGPHPSI 156 482 12 | 48" | 2 | 12" | | | |

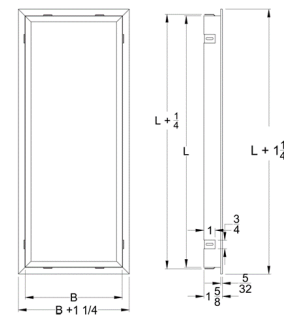

| PHP-TBPF- Plenum Slot Trim Frames | | | | | |
|-----------------------------------|------------|-------------|---------------|-----------|--|
| Model | Slot Width | Slot Length | Slot Quantity | "B" Width | |
| GHXGPHPTBPF 10 24 1 | 1" | 24" | 1 | 2-1/4" | |
| GHXGPHPTBPF 10 48 1 | 1" | 48" | 1 | 2-1/4" | |
| GHXGPHPTBPF 10 24 2 | 1" | 24" | 2 | 4-1/4" | |
| GHXGPHPTBPF 10 48 2 | 1" | 48" | 2 | 4-1/4" | |
| GHXGPHPTBPF 15 24 1 | 1-1/2" | 24" | 1 | 2-3/4" | |
| GHXGPHPTBPF 15 48 1 | 1-1/2" | 48" | 1 | 2-3/4" | |
| GHXGPHPTBPF 15 48 2 | 1-1/2" | 48" | 2 | 5-1/4" | |

Accessories
 PHPTBPF-Trim frames
 ROD-Face Operable Dampers

| Cross Reference | |
|-----------------|-----------|
| Brand | Model |
| Titus | TBDI-80 |
| Price | TBDI-4100 |
| Nailor | 5700 |
| Krueger | PTBS |

DALLAS
 10350 Olympic Drive
 Dallas, TX 75220
 800.539.4633 Toll Free
 214.350.6871 Main Line

FORT WORTH
 2901 Wesley Way
 Fort Worth, TX 76118
 800.858.8497 Toll Free
 682.253.0122 Main Line



Single Duct VAV Terminal Unit

1/2" Dual Density Fiberglass Liner
 Controls Enclosure
 Slip and Drive Discharge Connection
 Cooling Only

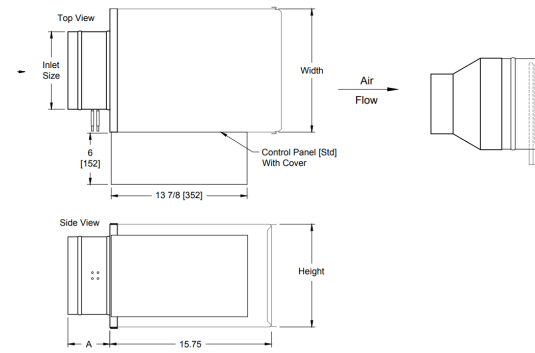

| VAVTH- Single Duct VAV Terminal | | | | | | |
|---------------------------------|-------|---------|-------|--------|---------|--------|
| Model | Inlet | Inlet A | Width | Height | Weight | |
| GHXGVAVTH06 | 06" | 5-7/8" | 5" | 12" | 8" | 12 lbs |
| GHXGVAVTH08 | 08" | 7-7/8" | 5" | 12" | 10" | 15 lbs |
| GHXGVAVTH10 | 10" | 9-7/8" | 5" | 14" | 12-1/2" | 18 lbs |
| GHXGVAVTH12 | 12" | 11-7/8" | 5" | 16" | 15" | 22 lbs |
| GHXGVAVTH14 | 14" | 13-7/8" | 5" | 20" | 17-1/2" | 24 lbs |

| Accessories | |
|--------------|-------------------------------------|
| Model | Description |
| GHXGVAVCONAN | Analog Electric Control with T-Stat |
| GHXGVCONPN | Pneumatic Controls |



Parallel Fan Powered Terminal Unit

1" Dual Density Fiberglass Liner
 Controls Enclosure
 Slip and Drive Discharge Connection
 PSC Motor
 Staged Heat Electric Heating Coils
 1" Thick Throw away Filter

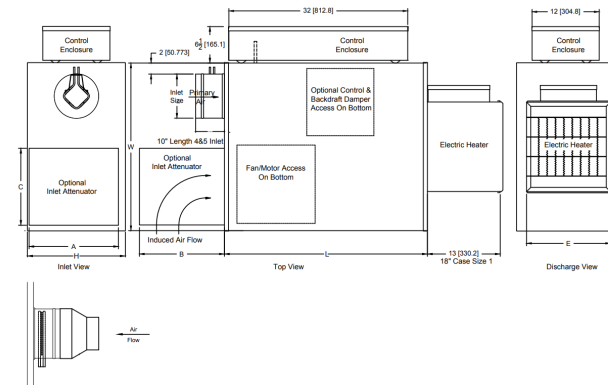

| FVI-Parallel Fan Powered Terminal | | | | | | | | | | | |
|-----------------------------------|--------------------|-----|-------|--------|----------|-----------|-------|--------|----------------|---------|-------|
| Model | Heater Information | | | | | Unit Size | | | Discharge Size | | |
| | Inlet | HP | Motor | KW | Voltage | Height | Width | Length | Loc | Height | Width |
| GHXGFVI506C1 | 06" | 1/8 | 277V | 3KW | 480V/3PH | 17-1/2" | 30" | 36" | 2-1/2" | 15" | 16" |
| GHXGFVI508C2 | 08" | 1/8 | 277V | 5 KW | 480V/3PH | 17-1/2" | 30" | 36" | 2-1/2" | 15" | 16" |
| GHXGFVI510C3 | 10" | 1/4 | 277V | 7.5 KW | 480V/3PH | 17-1/2" | 36" | 40" | 6-1/4" | 15" | 16" |
| GHXGFVI512C4 | 12" | 1/4 | 277V | 10 KW | 480V/3PH | 17-1/2" | 36" | 40" | 4-1/4" | 17-1/2" | 20" |
| GHXGFVI514C6 | 14" | 1/2 | 277V | 15 KW | 480V/3PH | 20" | 40" | 40" | 5" | 17-1/2" | 20" |

| Accessories | |
|-------------|---|
| Model | Description |
| MAFPREHEAT | Reheat Module for Fan Powered Terminals |

DALLAS
 10350 Olympic Drive
 Dallas, TX 75220
 800.539.4633 Toll Free
 214.350.6871 Main Line

FORT WORTH
 2901 Wesley Way
 Fort Worth, TX 76118
 800.858.8497 Toll Free
 682.253.0122 Main Line



Cabinet Exhaust Fans

- 115V Motor
- Backdraft Damper
- Round Outlet
- Plug Disconnect
- Mounting Brackets



| SP/CSP- Cabinet Fans | | | | | | |
|----------------------|------|----------|------|------|-------|--------------|
| Model | CFM | Static | RPM | AMPS | WATTS | Sones @ 0 in |
| GHSPC50 | 44 | .125" SP | 1680 | .80 | 46 | 2.9 |
| GHSPB110 | 111 | .125" SP | 950 | 1.14 | 80 | 2.0 |
| GHSPB150 | 155 | .125" SP | 1050 | 1.70 | 129 | 3.0 |
| GHSPB200 | 195 | .125" SP | 1100 | 2.20 | 173 | 4.4 |
| GHSPA250 | 246 | .125" SP | 1000 | .77 | 83 | 2.9 |
| GHSPA390 | 392 | .125" SP | 1350 | 1.34 | 135 | 5.4 |
| GHSPA410 | 405 | .125" SP | 1000 | 1.74 | 121 | 4.1 |
| GHCSPA780 | 775 | .125" SP | 1600 | 3.77 | 405 | 10.2 |
| GHSPA780 | 775 | .125" SP | 1600 | 3.30 | 348 | 10.2 |
| GHSPA1050 | 1093 | .125" SP | 1095 | 6.30 | 420 | 7.2 |

| Accessories | |
|-------------|---|
| Model | Description |
| GHSPBGRILLE | Plastic Grille |
| GHVIKIT | Isolation Kit |
| GH5WSSC | Speed Controller Up to Size A780 |
| GH10WSSC | Speed Controller Size A150 |
| GHTSTAT2HA | T-stat 2 Stage Heating 1 Stage Cooling Up to 3/4 HP |



High Volume Low Speed Fan

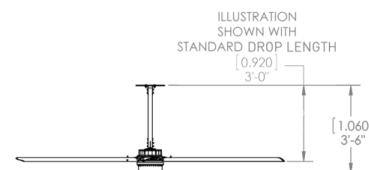

| TB- HVLS Fans | | | | |
|---------------|-------|--------------|-------------|---------|
| Model | Style | Blade Length | Blade Count | HP |
| MTB0606 | 370 | 06' | 6 | .25 HP |
| MTB0806 | 370 | 08' | 6 | .25 HP |
| MTB1006 | 370 | 10' | 6 | .25 HP |
| MTB1206 | 370 | 12' | 6 | .25 HP |
| MTB1406 | 370 | 14' | 6 | .25 HP |
| MTB1603 | 430 | 16' | 3 | 1.05 HP |
| MTB1803 | 430 | 18' | 3 | 1.05 HP |
| MTB1606 | 550 | 16' | 6 | 1.05 HP |
| MTB1806 | 550 | 18' | 6 | 1.05 HP |
| MTB2006 | 780 | 20' | 6 | 2.10 HP |
| MTB2406 | 780 | 24' | 6 | 2.10 HP |

| Accessories | |
|-------------|---|
| Model | Description |
| MTM3706 | Motor and Hardware for Model 3706-110V-220V |
| MTM4303 | Motor and Hardware for Model 4303 208V-240V |
| MTM5506 | Motor and Hardware for Model 5506 120V-277V |
| MTM7806 | Motor and Hardware for Model 7806 380V-600V |

DALLAS
10350 Olympic Drive
Dallas, TX 75220
800.539.4633 Toll Free
214.350.6871 Main Line

FORT WORTH
2901 Wesley Way
Fort Worth, TX 76118
800.858.8497 Toll Free
682.253.0122 Main Line



V4004D- Double Deflection Supply Grille

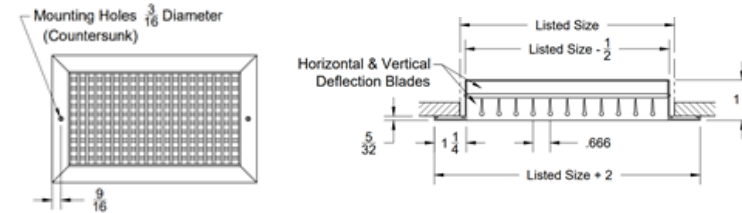

- Blades Parallel to Vertical
- Aluminum Construction
- Opposed Blade Damper
- Surface Mount Border 1
- White Finish

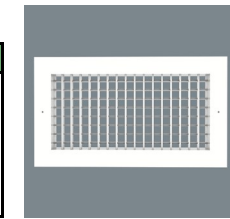

| V4004D- Double Deflection | | |
|---------------------------|-----------|-----------|
| Model | Neck | Face |
| GHXGV40041 06x06 OBDA | 06" x 06" | 08" x 08" |
| GHXGV40041 08x04 OBDA | 08" x 04" | 10" x 06" |
| GHXGV40041 08x06 OBDA | 08" x 06" | 10" x 08" |
| GHXGV40041 08x08 OBDA | 08" x 08" | 10" x 10" |
| GHXGV40041 10x04 OBDA | 10" x 04" | 12" x 06" |
| GHXGV40041 10x06 OBDA | 10" x 06" | 12" x 08" |
| GHXGV40041 10x08 OBDA | 10" x 08" | 12" x 10" |
| GHXGV40041 10x10 OBDA | 10" x 10" | 12" x 12" |
| GHXGV40041 12x04 OBDA | 12" x 04" | 14" x 06" |
| GHXGV40041 12x06 OBDA | 12" x 06" | 14" x 08" |
| GHXGV40041 12x08 OBDA | 12" x 08" | 14" x 10" |
| GHXGV40041 12x10 OBDA | 12" x 10" | 14" x 12" |
| GHXGV40041 12x12 OBDA | 12" x 12" | 14" x 14" |
| GHXGV40041 14x04 OBDA | 14" x 04" | 16" x 06" |
| GHXGV40041 14x06 OBDA | 14" x 06" | 16" x 08" |
| GHXGV40041 14x08 OBDA | 14" x 08" | 16" x 10" |
| GHXGV40041 14x10 OBDA | 14" x 10" | 16" x 12" |
| GHXGV40041 14x12 OBDA | 14" x 12" | 16" x 14" |
| GHXGV40041 14x14 OBDA | 14" x 14" | 16" x 16" |
| GHXGV40041 16x06 OBDA | 16" x 06" | 18" x 08" |
| GHXGV40041 16x08 OBDA | 16" x 08" | 18" x 10" |
| GHXGV40041 16x10 OBDA | 16" x 10" | 18" x 12" |
| GHXGV40041 16x12 OBDA | 16" x 12" | 18" x 14" |
| GHXGV40041 16x14 OBDA | 16" x 14" | 18" x 16" |
| GHXGV40041 18x06 OBDA | 18" x 06" | 20" x 08" |
| GHXGV40041 18x08 OBDA | 18" x 08" | 20" x 10" |
| GHXGV40041 18x10 OBDA | 18" x 10" | 20" x 12" |
| GHXGV40041 18x12 OBDA | 18" x 12" | 20" x 14" |
| GHXGV40041 18x14 OBDA | 18" x 14" | 20" x 16" |
| GHXGV40041 20x06 OBDA | 20" x 06" | 22" x 08" |
| GHXGV40041 20x08 OBDA | 20" x 08" | 22" x 10" |
| GHXGV40041 20x10 OBDA | 20" x 10" | 22" x 12" |
| GHXGV40041 20x12 OBDA | 20" x 12" | 22" x 14" |
| GHXGV40041 20x14 OBDA | 20" x 14" | 22" x 16" |

| Cross Reference | |
|-----------------|--------|
| Brand | Model |
| Titus | 300FL |
| Price | 620 |
| Nailor | 51DV-O |
| Krueger | 5880 |

| V4004D- Double Deflection | | |
|---------------------------|-----------|-----------|
| Model | Neck | Face |
| GHXGV40041 22x06 OBDA | 22" x 06" | 24" x 08" |
| GHXGV40041 22x08 OBDA | 22" x 08" | 24" x 10 |
| GHXGV40041 22x10 OBDA | 22" x 10" | 24" x 12" |
| GHXGV40041 22x12 OBDA | 22" x 12" | 24" x 14" |
| GHXGV40041 22x14 OBDA | 22" x 14" | 24" x 16" |
| GHXGV40041 24x06 OBDA | 24" x 06" | 26" x 08" |
| GHXGV40041 24x08 OBDA | 24" x 08" | 26" x 10" |
| GHXGV40041 24x10 OBDA | 24" x 10" | 26" x 12" |
| GHXGV40041 24x12 OBDA | 24" x 12" | 26" x 14" |
| GHXGV40041 24x14 OBDA | 24" x 14" | 26" x 16" |
| GHXGV40041 26x06 OBDA | 26" x 06" | 28" x 08" |
| GHXGV40041 26x08 OBDA | 26" x 08" | 28" x 10" |
| GHXGV40041 26x10 OBDA | 26" x 10" | 28" x 12" |
| GHXGV40041 26x12 OBDA | 26" x 12" | 28" x 14" |
| GHXGV40041 26x14 OBDA | 26" x 14" | 28" x 16" |
| GHXGV40041 28x06 OBDA | 28" x 06" | 30" x 08" |
| GHXGV40041 28x08 OBDA | 28" x 08" | 30" x 10" |
| GHXGV40041 28x10 OBDA | 28" x 10" | 30" x 12" |
| GHXGV40041 28x12 OBDA | 28" x 12" | 30" x 14 |
| GHXGV40041 28x14 OBDA | 28" x 14" | 30" x 16" |
| GHXGV40041 30x06 OBDA | 30" x 06" | 32" x 08" |
| GHXGV40041 30x08 OBDA | 30" x 08" | 32" x 10" |
| GHXGV40041 30x10 OBDA | 30" x 10" | 32" x 12" |
| GHXGV40041 30x12 OBDA | 30" x 12" | 32" x 14" |
| GHXGV40041 30x14 OBDA | 30" x 14" | 32" x 16" |
| GHXGV40041 36x06 OBDA | 36" x 06" | 38" x 08" |
| GHXGV40041 36x08 OBDA | 36" x 08" | 38" x 10" |
| GHXGV40041 36x12 OBDA | 36" x 12" | 38" x 14" |



LS4D-Curved Blade with Opposed Blade Damper

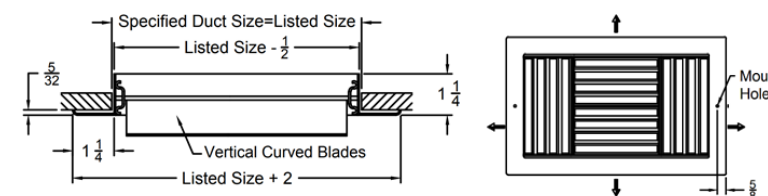

- Aluminum Construction
- Surface Mount Border 1
- Opposed Blade damper
- White Finish

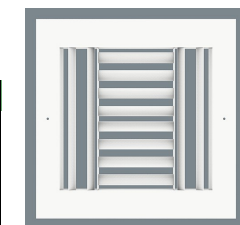

| LS4D- Curved Blade Supply | | |
|---------------------------|-----------|-----------|
| Model Number | Neck | Face |
| MALS41 06x06 01OBDA | 06" x 06" | 08" x 08" |
| MALS41 08x08 01OBDA | 08" x 08" | 10" x 10" |
| MALS41 10x10 01OBDA | 10" x 10" | 12" x 12" |
| MALS41 12x12 01OBDA | 12" x 12" | 14" x 14" |
| MALS41 14x14 01OBDA | 14" x 14" | 16" x 16" |

| Cross Reference | |
|-----------------|----------|
| Brand | Model |
| Titus | 250-AA |
| Price | CVD |
| Nailor | 51C-O 4A |
| Krueger | 5180 |

DALLAS
10350 Olympic Drive
Dallas, TX 75220
800.539.4633 Toll Free
214.350.6871 Main Line

FORT WORTH
2901 Wesley Way
Fort Worth, TX 76118
800.858.8497 Toll Free
682.253.0122 Main Line



4004P- Universal Double Deflection Spiral Pipe Grille



Aluminum Construction
Surface Mount Border 1
Extractor Damper Plate
Mill Finish

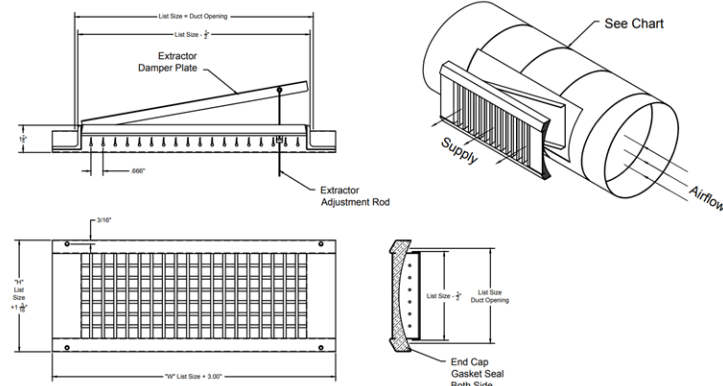

| Cross Reference | |
|-----------------|---------|
| Brand | Model |
| Titus | US300FL |
| Price | SDG |
| Krueger | 5DMGDU |

| 4004P- Aluminum Spiral Grille | | | |
|-------------------------------|-----------|-----------|--|
| Model Number | Neck | Face | |
| GHXG4004P1 24 12x04 | 12" x 04" | 14" x 06" | |
| GHXG4004P1 24 12x06 | 12" x 06" | 14" x 08" | |
| GHXG4004P1 24 18x04 | 18" x 04" | 20" x 06" | |
| GHXG4004P1 24 18x06 | 18" x 06" | 20" x 08" | |
| GHXG4004P1 24 20x06 | 20" x 06" | 22" x 08" | |

DG- Door Grille



Aluminum Construction
Surface Mount Border 1
White Finish

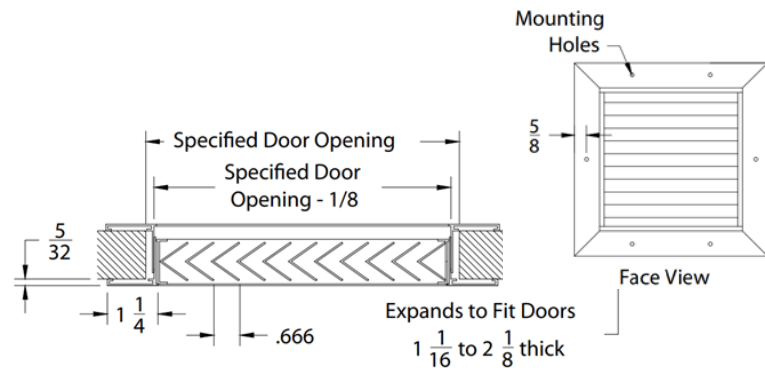

| Cross Reference | |
|-----------------|---------|
| Brand | Model |
| Titus | CT-700L |
| Price | ATG1 |
| Nailor | 61DFD |
| Krueger | 5600A |

| DG- Door Grille | | | |
|-------------------|-----------|-----------|--|
| Model Number | Neck | Face | |
| GHXGDGDF 12x12 01 | 12" x 12" | 14" x 14" | |
| GHXGDGDF 18x12 01 | 18" x 12" | 20" x 14" | |
| GHXGDGDF 18x18 01 | 18" x 18" | 20" x 20" | |
| GHXGDGDF 24x12 01 | 24" x 12" | 26" x 14" | |
| GHXGDGDF 24x18 01 | 24" x 18" | 26" x 20" | |
| GHXGDGDF 24x24 01 | 24" x 24" | 26" x 26" | |

SPRTB-Perforated Panel Return



Steel Construction
Lay-in border 6
White Finish

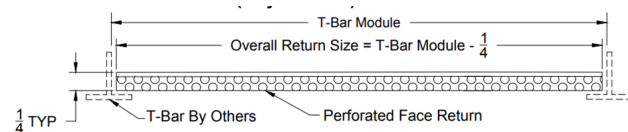
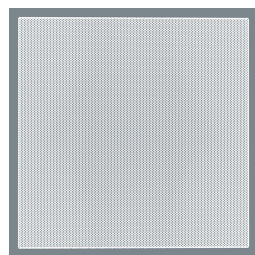

| SPRTB-STEEL PANEL | | |
|--------------------|-----------|-----------|
| Model Number | Neck | Face |
| GHXGSPRTB 24/12 01 | 22" x 10" | 24" x 12" |
| GHXGSPRTB 24 01 | 22" x 22" | 24" x 24" |

| Cross Reference | |
|-----------------|-------|
| Brand | Model |
| Titus | PXP |
| Price | PFRF |
| Nailor | 4302 |
| Krueger | 57670 |



Gravity Ventilators

| GRS Gravity Ventilator | | | |
|------------------------|----------|-----------|----------------------------|
| Model | Diameter | Curb Cap | Separate Curb, If Required |
| GHGRS08 | 08" | 19" x 19" | GHGPI19 |
| GHGRS10 | 10" | 19" x 19" | GHGPI19 |
| GHGRS12 | 12" | 22" x 22" | GHGPI22 |
| GHGRS16 | 16" | 26" x 26" | GHGPI26 |
| GHGRS20 | 20" | 30" x 30" | GHGPI30 |
| GHGRS24 | 24" | 34" x 34" | GHGPI34 |

Extruded Aluminum Construction
Integral bird screen
Curb Cap Adapter

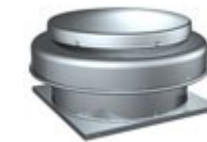

Downblast Centrifugal Roof Mounted Fans

| G/GB Down blast Centrifugal Fans | | | | |
|----------------------------------|--------|------------------|-----------|-----------------------|
| Model | Motor | CFM / Pressure | Curb Cap | Add Curb, If Required |
| GHG070 | Direct | 274 / .25" S.P. | 17" x 17" | GHGPI17 |
| GHGB081 | Belt | 400 / .25" S.P. | 19" x 19" | GHGPI19 |
| GHGB101 | Belt | 600 / .25" S.P. | 19" x 19" | GHGPI19 |
| GHGB121 | Belt | 1,100 / .5" S.P. | 19" x 19" | GHGPI19 |

Spun Aluminum
120V/1PH Motor
NEMA-1 Disconnect
Bird screen



| Motor Accessories | |
|-------------------|---|
| Model | Description |
| GHMS1P1 | Motor Starter Single Phase |
| GHMSAC132J40 | Motor Starter 460V 3HP to 7.5 HP |
| GHTSTAT2HA | T-stat 2 Stage Heating 1 Stage Cooling Up to 3/4 HP |



Insulated Roof Curbs

| Roof Curbs | | | |
|------------|-------------------|-----------|---------------|
| Model | Curb O.D. | Curb I.D. | Fits Curb Cap |
| GHGPI17 | 15-1/2" x 15-1/2" | 12" x 12" | 17" x 17" |
| GHGPI19 | 17-1/2" x 17-1/2" | 14" x 14" | 19" x 19" |
| GHGPI22 | 20-1/2" x 20-1/2" | 17" x 17" | 22" x 22" |
| GHGPI26 | 24-1/2" x 24-1/2" | 21" x 21" | 26" x 26" |
| GHGPI30 | 28-1/2" x 28-1/2" | 25" x 25" | 30" x 30" |
| GHGPI34 | 32-1/2" x 32-1/2" | 29" x 29" | 34" x 34" |

Steel Construction
Insulation

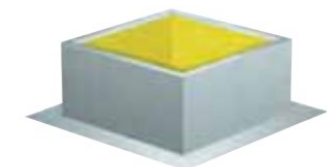

| Curb Accessories | |
|------------------|--------------------------------------|
| Model | Description |
| GHDTGPI1708 | 8" Tray for Roof Curb GPI-17 |
| GHDTGPI1710 | 10" Tray for Roof Curb GPI-17 |
| GHDTGPI1908 | 8" Tray for Roof Curb GPI-19 |
| GHDTGPI1910 | 10" Tray for Roof Curb GPI-19 |
| GHDTGPI1912 | 12" Tray for Roof Curb GPI-19 |
| GHDTGPI2212 | 12" Tray for Roof Curb GPI-22 |
| GHDTGPI2216 | 16" Tray for Roof Curb GPI-22 |
| GHDTGPI2616 | 16" Damper Tray for Roof Curb GPI-26 |
| GHDTGPI3018 | 18" Tray for GPI-30 |
| GHDTGPI3424 | 24" Tray for GPI-34 |

DALLAS
10350 Olympic Drive
Dallas, TX 75220
800.539.4633 Toll Free
214.350.6871 Main Line

FORT WORTH
2901 Wesley Way
Fort Worth, TX 76118
800.858.8497 Toll Free
682.253.0122 Main Line

DALLAS
10350 Olympic Drive
Dallas, TX 75220
800.539.4633 Toll Free
214.350.6871 Main Line

FORT WORTH
2901 Wesley Way
Fort Worth, TX 76118
800.858.8497 Toll Free
682.253.0122 Main Line



Combination Fire Smoke Dampers



Class 1 Rated
Triple Grove Blade
12" Sleeve
Double Retaining Angles-Loose

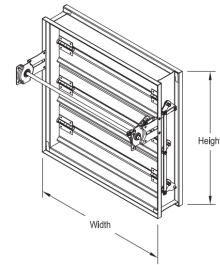
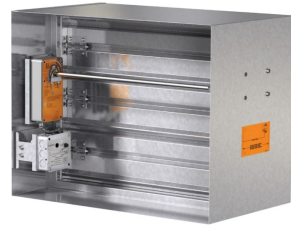

| FSD211 - Fire Smoke Damper | |
|----------------------------|-----------|
| Model | Size |
| GHFSD1212 | 12" x 12" |
| GHFSD1812 | 18" x 12" |
| GHFSD2412 | 24" x 12" |

Round Combination Fire Smoke Dampers



Class 1 Rated
Triple Grove Blade
12" Sleeve
Double Retaining Angles-Loose
Round Duct Adapter

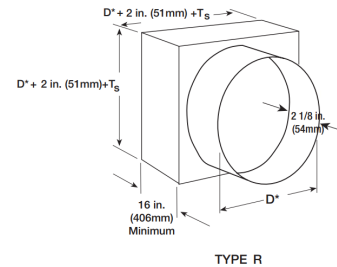

| Fire Smoke Damper | |
|-------------------|------|
| Model | Size |
| GHFSDR06 | 06" |
| GHFSDR08 | 08" |
| GHFSDR10 | 10" |
| GHFSDR12 | 12" |
| GHFSDR14 | 14" |

Backdraft Damper



Steel Construction
Vinyl Blade Seals

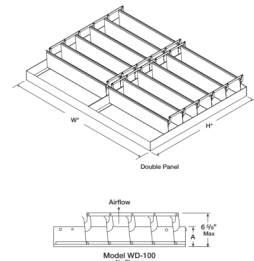

| WD-100 Backdraft Damper | |
|-------------------------|-----------|
| Model | Size |
| GHWD10008 | 10" x 08" |
| GHWD10010 | 10" x 10" |
| GHWD10012 | 10" x 12" |
| GHBR302020 | 30" x 20" |

Fixed Blade Louver



4" Deep, Fixed "J" Blade
Extruded Aluminum Finish
Mill Finish

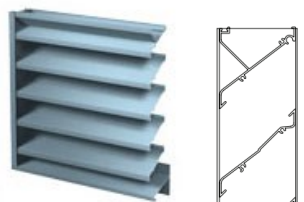

| ESJ Fixed Blade Louver | | | |
|------------------------|--------------|-------------------|---------|
| Model | Opening Size | Actual Size | Frame |
| GHEJ4011212 | 12" x 12" | 11-3/4" x 11-3/4" | Channel |
| GHEJ4011818 | 18" x 18" | 17-3/4" x 17-3/4" | Channel |
| GHEJ4012412 | 24" x 12" | 23-3/4" x 23-3/4" | Channel |
| GHEJ4012424 | 24" x 24" | 24-3/4" x 11-3/4" | Channel |
| GHEJ4011212F | 12" x 12" | 11-3/4" x 11-3/4" | Flange |
| GHEJ4011812F | 18" x 12" | 17-3/4" x 11-3/4" | Flange |
| GHEJ4011818F | 18" x 18" | 17-3/4" x 17-3/4" | Flange |
| GHEJ4012412F | 24" x 12" | 23-3/4" x 23-3/4" | Flange |
| GHEJ4012424F | 24" x 24" | 24-3/4" x 11-3/4" | Flange |

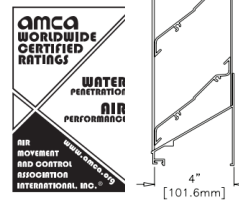

| Accessories | | |
|-------------|-----------|-------------|
| Model | Size | Description |
| GHFK1212 | 12" x 12" | Flange Kit |
| GHFK1818 | 18" x 18" | Flange Kit |
| GHFK2412 | 24" x 12" | Flange Kit |
| GHFK2424 | 24" x 24" | Flange Kit |



7500R-Perforated Return- No Pattern Controller- Round

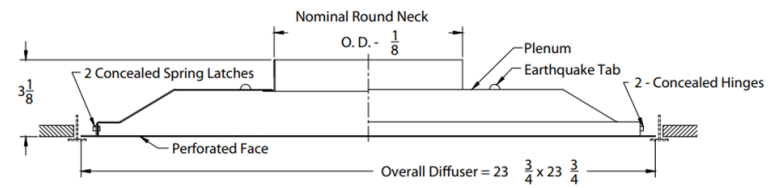

Steel Construction
Lay-in border 6
White Finish

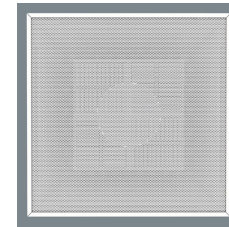

| 7500R-STEEL- ROUND NECK | | |
|-------------------------|------|-----------|
| Model Number | Neck | Face |
| GHXG7500R6 06/12 01 | 06" | 12" x 12" |
| GHXG7500R6 06/24 01 | 06" | 24" x 24" |
| GHXG7500R6 08/24 01 | 08" | 24" x 24" |
| GHXG7500R6 10/24 01 | 10" | 24" x 24" |
| GHXG7500R6 12/24 01 | 12" | 24" x 24" |
| GHXG7500R6 14/24 01 | 14" | 24" x 24" |
| GHXG7500R6 16/24 01 | 16" | 24" x 24" |
| GHXG7500R6 18/24 01 | 18" | 24" x 24" |

Accessories
TBPF-Trim frames
BDS-Steel butterfly dampers
RDS- Steel radial dampers
FCBP- Fiberglass backpan

| Cross Reference | |
|-----------------|-------|
| Brand | Model |
| Titus | PAR |
| Price | PDDR |
| Nailor | 4360 |
| Krueger | S80P |



7550R-Perforated Return-Square/Rectangular Neck

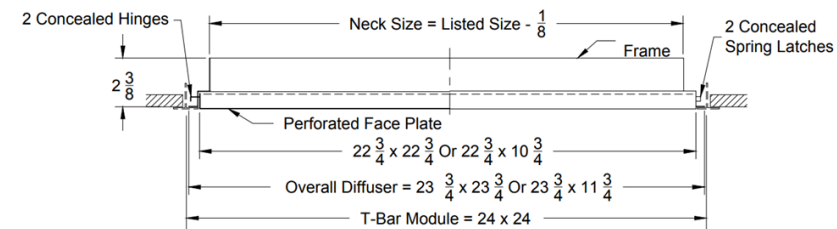

Steel Construction
Lay-in border 6
White Finish

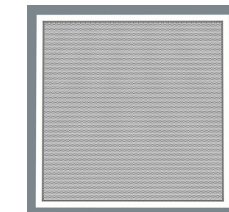

| 7550R-STEEL- Square/Rectangular Neck | | |
|--------------------------------------|-----------|-----------|
| Model Number | Neck | Face |
| TBPR2020LT | 18" x 18" | 20" X 20" |
| GHXG7550R622X10/2412 | 22" x 10" | 24" x 12" |
| GHXG7550R6 22x22/24 | 22" x 22" | 24" x 24" |

| Cross Reference | |
|-----------------|-------|
| Brand | Model |
| Titus | PAR |
| Price | PDDR |
| Nailor | 4360 |
| Krueger | S80P |

Accessories
TBPF-Trim frames
DMSR- Square to Rounds



7000R-Perforated Return-Square/Rectangular Neck

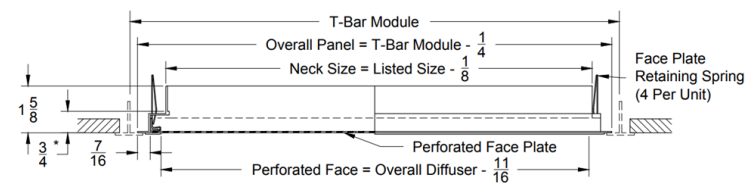

Aluminum Construction
Lay-in border 6
White Finish

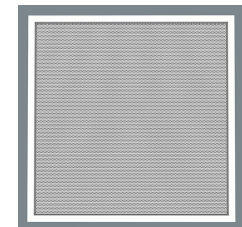

| 7000R-ALUMINUM RETURN | | |
|-----------------------|-----------|-----------|
| Model Number | Neck | Face |
| GHXG7000R6 10x10/12 | 10" x 10" | 12" x 12" |
| GHXG7000R6 10x22/2212 | 22" x 10" | 24" x 12" |
| GHXG7000R6 22x22/24 | 22" x 22" | 24" x 24" |
| GHXG7000R622x46/4824 | 46" x 22" | 48" x 24" |

| Cross Reference | |
|-----------------|--------|
| Brand | Model |
| Titus | PAR-AA |
| Price | APDDR |
| Nailor | 6500 |
| Krueger | S580P |

Accessories
TBPF-Trim frames
DMSR- Square to rounds
(Excludes 48"X24")

DALLAS
10350 Olympic Drive
Dallas, TX 75220
800.539.4633 Toll Free
214.350.6871 Main Line

FORT WORTH
2901 Wesley Way
Fort Worth, TX 76118
800.858.8497 Toll Free
682.253.0122 Main Line

DALLAS
10350 Olympic Drive
Dallas, TX 75220
800.539.4633 Toll Free
214.350.6871 Main Line

FORT WORTH
2901 Wesley Way
Fort Worth, TX 76118
800.858.8497 Toll Free
682.253.0122 Main Line



RPD- Perforated Return with Opposed Blade Damper



Surface Mounted
Aluminum Construction
Opposed Blade Damper
Surface Mount Border 1

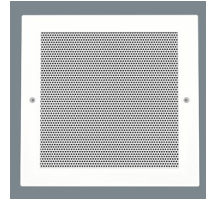
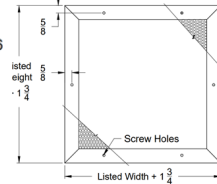
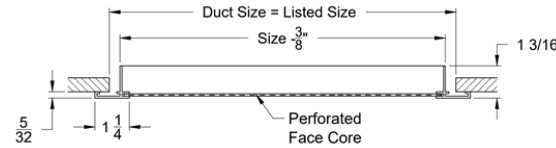

| RPD-Perforated-Surface Mounted | | |
|--------------------------------|-----------|-----------|
| Model | Neck | Face |
| GHXGRP1 06x06 01OBDA | 06" X 06" | 08" X 08" |
| GHXGRP1 08x08 01OBDA | 08" X 08" | 10" X 10" |
| GHXGRP1 10x10 01OBDA | 10" X 10" | 12" X 12" |
| GHXGRP1 12x12 01OBDA | 12" X 12" | 14" X 14" |

| Cross Reference | |
|-----------------|---------|
| Brand | Model |
| Titus | 8F |
| Price | 10F |
| Nailor | 51PR-OA |
| Krueger | S580P |

RPF- Perforated Return with Filter Frame



Aluminum Construction
1" Filter Frame (Filters by Others)
Lay-in Border 6
White Finish

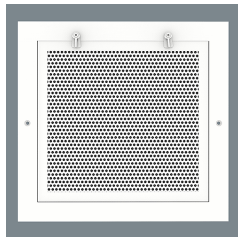
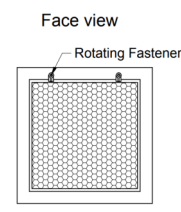
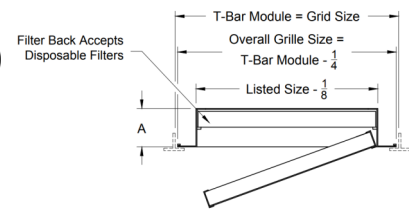

| RPF-Perforated Filter Return | | |
|------------------------------|-----------|-----------|
| Model | Neck | Face |
| GHXGRPF6 20x20/24 01 | 20" x 20" | 24" x 24" |
| GHXGRPF6 10x22/12/24 | 22" x 10" | 24" x 12" |
| GHXGRPF6 22x46/24/48 | 46" x 22" | 48" x 24" |

| Cross Reference | |
|-----------------|-----------|
| Brand | Model |
| Titus | 8FF |
| Price | 10FF |
| Nailor | 51FB |
| Krueger | S580P-5FF |

CC5-Aluminum Eggcrate



1/2" x 1/2" x 1/2" Core
Aluminum Construction
Lay-in border 6
White Finish

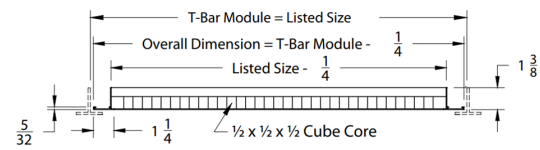

Accessories
TBPF-Trim frames
DMSR- Square to rounds

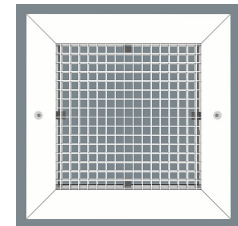

| CC5-Aluminum Eggcrate | | |
|-----------------------|-----------|-----------|
| Model Number | Neck | Face |
| GHXGCC56 10x10/12 01 | 10" x 10" | 12" X 12" |
| GHXGCC5622x10/2412 | 22" x 10" | 24" x 12" |
| GHXGCC56 22x22/24 01 | 22" x 22" | 24" x 24" |
| GHXGCC5646x22/4824 | 46" X 22" | 48" x 24" |

| Cross Reference | |
|-----------------|-------|
| Brand | Model |
| Titus | 50F |
| Price | 80 |
| Nailor | 51EC |
| Krueger | EGC5 |

CC5F-Aluminum Filter Eggcrate



1/2" x 1/2" x 1/2" Core
1" filter frame (Filters by others)
Aluminum Construction
Lay-in border 6
White Finish

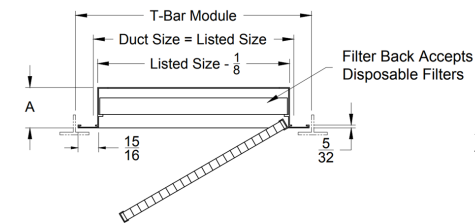

Accessories
TBPF-Trim frames
DMSR- Square to rounds

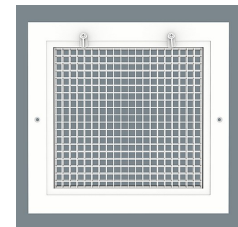

| CC45-Aluminum Filter-Proof Eggcrate | | |
|-------------------------------------|-----------|-----------|
| Model Number | Neck | Face |
| GHXGCC5F6 22x10/2412 | 22" x 10" | 24" X 12" |
| GHXGCC5F6 20x20/24 | 20" x 20" | 24" x 24" |
| GHXGCC5F6 46x22/4824 | 46" x 22" | 48" x 24" |

| Cross Reference | |
|-----------------|---------|
| Brand | Model |
| Titus | 50FF |
| Price | 80FF |
| Nailor | 51FE |
| Krueger | EGC55FF |

DALLAS
10350 Olympic Drive
Dallas, TX 75220
800.539.4633 Toll Free
214.350.6871 Main Line

FORT WORTH
2901 Wesley Way
Fort Worth, TX 76118
800.858.8497 Toll Free
682.253.0122 Main Line



Ceiling Radiation damper- Square/Rectangular

| CRD-Square Radiation Damper | |
|-----------------------------|-----------------|
| Model | Size |
| GHCRD602210 | 22" x 10" |
| GHCRD602222 | 22" x 22" |
| GHQB24 | Thermal Blanket |

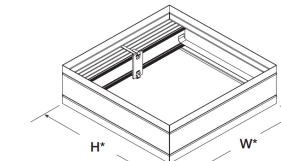

*W & H dimensions furnished approximately 1/4 in. (6mm) undersize.

Curtain Blade
Galvanized Steel Construction
3- Hour Rated

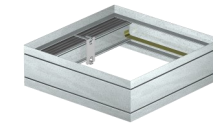

Ceiling Radiation damper- Round

| CRD- Round Radiation Damper | |
|-----------------------------|--------------|
| Model | Size |
| GHCRD206 | 06" |
| GHCRD208 | 08" |
| GHCRD210 | 10" |
| GHCRD212 | 12" |
| GHCRD214 | 14" |
| GHFUSECRD | Fusible Link |

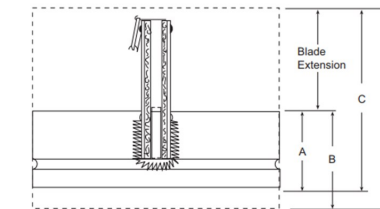

Butterfly Blade
Galvanized Steel Construction
3- Hour Rated



Fire Dampers-Square/Rectangular

| DFD-Dynamic Fire Dampers | | | |
|--------------------------|-----------|-------|-------------|
| Model | Size | Style | Orientation |
| GHDFDA2424V | 24" x 24" | A | VERTICAL |
| GHDFDB0808V | 08" x 08" | B | VERTICAL |
| GHDFDB1010V | 10" x 10" | B | VERTICAL |
| GHDFDB1212V | 12" x 12" | B | VERTICAL |
| GHDFDB1414V | 14" x 14" | B | VERTICAL |
| GHDFDB1616V | 16" x 16" | B | VERTICAL |
| GHDFDB2412V | 24" x 12" | B | VERTICAL |
| GHDFDB0808H | 08" x 08" | B | HORIZONTAL |
| GHDFDB1010H | 10" x 10" | B | HORIZONTAL |
| GHDFDB1212H | 12" x 12" | B | HORIZONTAL |
| GHDFDB1414H | 14" x 14" | B | HORIZONTAL |
| GHDFDB1616H | 16" x 16" | B | HORIZONTAL |
| GHDFDB2412H | 24" x 12" | B | HORIZONTAL |

Dynamic, 1 1/2 Hour Rated
12" Integral Sleeve
Double Retaining Angles-Loose

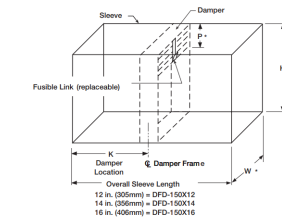

*These dimensions are furnished approximately 1/4 in. (6mm) undersize.



Fire Dampers-Round

| DFD-Dynamic Fire Dampers- Round | | |
|---------------------------------|--------------|-------------|
| Model | Size | Orientation |
| GHDFDR06V | 06" | VERTICAL |
| GHDFDR08V | 08" | VERTICAL |
| GHDFDR10V | 10" | VERTICAL |
| GHDFDR12V | 12" | VERTICAL |
| GHDFDR14V | 14" | VERTICAL |
| GHDFDR06H | 06" | HORIZONTAL |
| GHDFDR08H | 08" | HORIZONTAL |
| GHDFDR10H | 10" | HORIZONTAL |
| GHDFDR12H | 12" | HORIZONTAL |
| GHDFDR14H | 14" | HORIZONTAL |
| GHFUSEFD | Fusible Link | |

Dynamic, 1 1/2 Hour Rated
12" Integral Sleeve
Double Retaining Angles-Loose

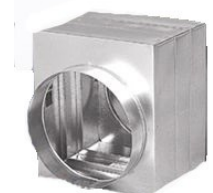
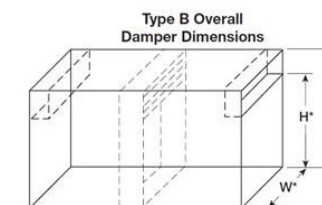

DALLAS
10350 Olympic Drive
Dallas, TX 75220
800.539.4633 Toll Free
214.350.6871 Main Line

FORT WORTH
2901 Wesley Way
Fort Worth, TX 76118
800.858.8497 Toll Free
682.253.0122 Main Line



CAM Lock Square Duct Access Door

Galvanized steel
1" Insulated Duct board
White finish

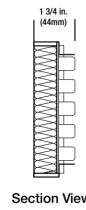
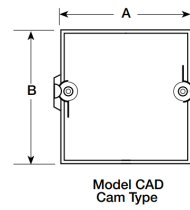

| CAD-Cam Lock Access Door | |
|--------------------------|-----------|
| Model | Size |
| GHCAD1006 | 06" x 06" |
| GHCAD1008 | 08" x 08" |
| GHCAD1010 | 10" x 10" |
| GHCAD1012 | 12" x 12" |
| GHCAD1014 | 14" x 14" |
| GHCAD1016 | 16" x 16" |
| GHCAD1018 | 18" x 18" |
| GHCAD1024 | 24" x 24" |

Round Duct Insulated Access Door

Galvanized Steel
Close cell neoprene gasket
Mill Finish

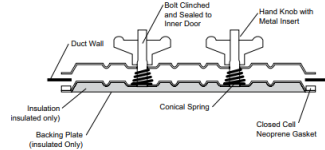

| RAD-Round Duct Access Door | | |
|----------------------------|-----------|-----------|
| Model | Door Size | Duct Size |
| GHRAD06 | 08" x 04" | 06" |
| GHRAD08 | 08" x 04" | 08" |
| GHRAD10 | 12" x 08" | 10" |
| GHRAD12 | 12" x 08" | 12" |
| GHRAD14 | 12" x 08" | 14" |
| GHRAD16 | 16" x 12" | 16" |
| GHRAD18 | 16" x 12" | 18" |

MILM-Steel Plaster Access Door

Galvanized steel
CAM Latches
White finish

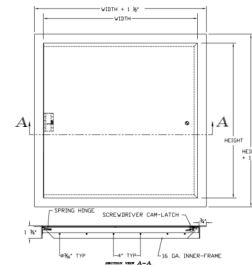

| MILM-Plaster Access Door | | | |
|--------------------------|-----------|-------------------|---------|
| Model | Door | Overall | Latches |
| MILM0808 | 08" x 08" | 9-1/2" x 9-1/2" | 1 |
| MILM1212 | 12" x 12" | 13-1/2" x 13-1/2" | 1 |
| MILM1616 | 16" x 16" | 17-1/2" x 17-1/2" | 1 |
| MILM1818 | 18" x 18" | 19-1/2" x 19-1/2" | 1 |
| MILM2424 | 24" x 24" | 25-1/2" x 25-1/2" | 4 |

Stainless Steel Plaster Access Door

304 Stainless Steel
CAM Latches
White finish

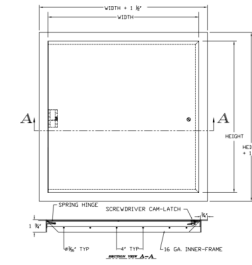

| MILMSS-Plaster Access Door | | | |
|----------------------------|-----------|-------------------|---------|
| Model | Door | Overall | Latches |
| MIL1212SS | 12" x 12" | 13-1/2" x 13-1/2" | 1 |

Fire Rated Plaster Access Door

Galvanized steel
Prime Coat Finish

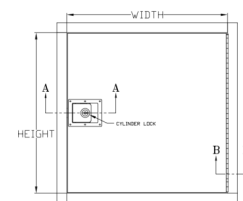

| MILFR-Fire Rated Access Door | | | |
|------------------------------|-----------|-------------------|---------|
| Model | Door | Overall | Latches |
| MILFR1212 | 12" x 12" | 12-1/2" x 12-1/2" | 1 |
| MILFR1616 | 16" x 16" | 16-1/2" x 16-1/2" | 1 |
| MILFR1818 | 18" x 18" | 18-1/2" x 18-1/2" | 1 |
| MILFR2424 | 24" x 24" | 21-1/2" x 21-1/2" | 1 |

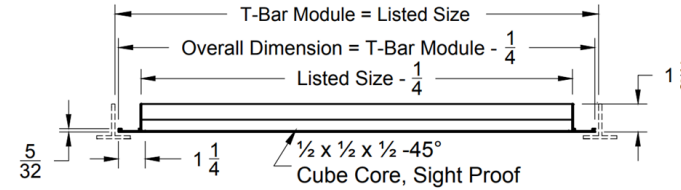

CC45-Sight-Proof Eggcrate

45° Deflection 1/2" x 1/2" x 1/2" Core
Aluminum Construction
Lay-in border 6
White Finish

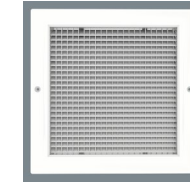

| CC45-Aluminum Sight-Proof Eggcrate | | |
|------------------------------------|-----------|-----------|
| Model Number | Neck | Face |
| GHXGCC456 10x10/12 | 10" x 10" | 12" x 12" |
| GHXGCC456 22x12/2412 | 22" x 10" | 24" x 12" |
| GHXGCC456 22x22/24 | 22" x 22" | 24" x 24" |

| Cross Reference | |
|-----------------|--------|
| Brand | Model |
| Titus | 45F |
| Price | 85 |
| Nailor | 51EC45 |
| Krueger | EGC545 |

Accessories
TBPF-Trim frames
DMSR- Square to rounds



CC5D-Eggcrate with Opposed Blade Damper- Surface Mount

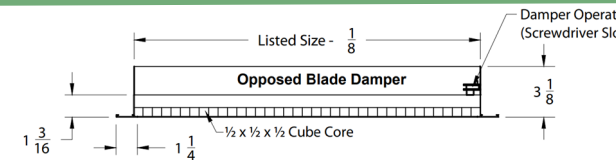

Aluminum Construction
Surface Mount Border 1
Opposed Blade damper
White Finish

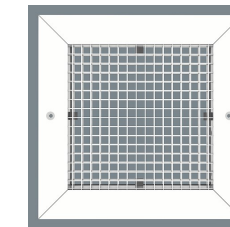

| CC5-ALUMINUM RETURN | | |
|-----------------------|-----------|-----------|
| Model Number | Neck | Face |
| GHXGCC51 06x06 01OBDA | 06" x 06" | 08" x 08" |
| GHXGCC51 08x08 01OBDA | 08" x 08" | 10" x 10" |
| GHXGCC51 10x10 01OBDA | 10" x 10" | 12" x 12" |
| GHXGCC51 12x12 01OBDA | 12" x 12" | 14" x 14" |
| GHXGCC51 14x14 01OBDA | 14" x 14" | 16" x 16" |
| GHXGCC51 16x16 01OBDA | 16" x 16" | 18" x 18" |
| GHXGCC51 18x18 01OBDA | 18" x 18" | 20" x 20" |
| GHXGCC51 24x12 01 | 24" x 12" | |

| Cross Reference | |
|-----------------|--------|
| Brand | Model |
| Titus | 50F |
| Price | 80D |
| Nailor | 51EC-O |
| Krueger | EGC5 |



CRE510- Aluminum Eggcrate

1/2" x 1/2" x 1" Core
Aluminum Construction
Lay-in border LT
White Finish

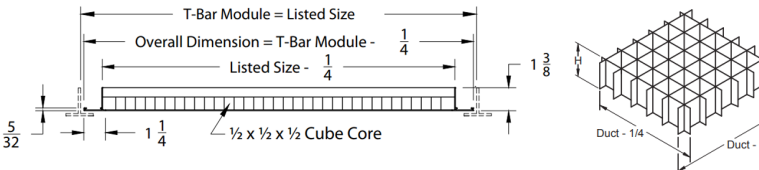

| CC5-Aluminum Eggcrate | | |
|-----------------------|-----------|-----------|
| Model Number | Neck | Face |
| GHXGCC56 10x10/12 01 | 10" x 10" | 12" x 12" |
| GHXGCC5622x10/2412 | 22" x 10" | 24" x 12" |
| GHXGCC56 22x22/24 01 | 22" x 22" | 24" x 24" |
| GHXGCC5646x22/4824 | 46" x 22" | 48" x 24" |

| Cross Reference | |
|-----------------|-------|
| Brand | Model |
| Titus | 50F |
| Price | 81 |
| Nailor | 51EC |
| Krueger | EGC5 |

Accessories
TBPF-Trim frames
DMSR- Square to rounds

LIEGG-PLASTIC EGGCRATE

| CC5-Aluminum Eggcrate | | |
|-----------------------|-----------|-----------|
| Model Number | Neck | Face |
| LIEGG2412 | 22" x 10" | 24" x 12" |
| LIEGG2424 | 22" x 22" | 24" x 24" |
| LIEGG4824 | 46" x 22" | 48" x 24" |

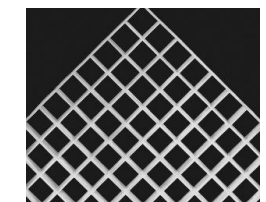

DALLAS
10350 Olympic Drive
Dallas, TX 75220
800.539.4633 Toll Free
214.350.6871 Main Line

FORT WORTH
2901 Wesley Way
Fort Worth, TX 76118
800.858.8497 Toll Free
682.253.0122 Main Line



RH- Fixed 45° Louver Return

Aluminum Construction
Lay-in Border 6

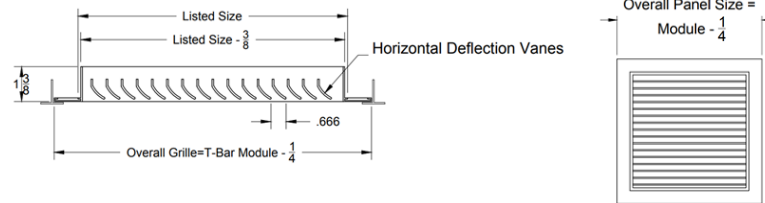

Accessories

TBPF-Trim frames
DMSR- Square to rounds
(Excludes 48" x 24")

| RH-Fixed Louver Return | | |
|------------------------|-----------|-----------|
| Model | Neck | Face |
| GHXGRH6 10x10/12 01 | 10" x 10" | 12" x 12" |
| GHXGRH6 22x10/24/12 | 22" x 10" | 24" x 12" |
| GHXGRH6 22x22/24 01 | 22" x 22" | 24" x 24" |
| GHXGRH6 46x22/48/24 | 46" x 22" | 48" x 24" |

| Cross Reference | |
|-----------------|-------|
| Brand | Model |
| Titus | 350FL |
| Price | 630 |
| Nailor | 5145H |
| Krueger | S580 |

RHF- Fixed 45° Louver Return with 1" Filter Frame

Aluminum Construction
1" Filter Frame (Filter by Others)
Lay-in Border 6
White Finish

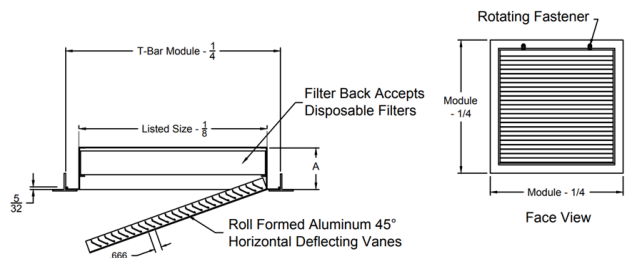
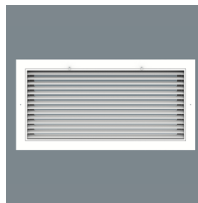

Accessories

TBPF-Trim frames
DMSR- Square to Rounds

| RHF-Fixed Louver Return | | |
|-------------------------|-----------|-----------|
| Model | Neck | Face |
| GHXGRHF6 20x20/24 | 20" x 20" | 12" x 12" |
| GHXGRHF6 22x10/24/12 | 22" x 10" | 24" x 12" |
| GHXGRHF6 46x22/48/24 | 46" x 22" | 48" x 24" |

| Cross Reference | |
|-----------------|----------|
| Brand | Model |
| Titus | 350FLF1 |
| Price | 630FF |
| Nailor | 51FBS45 |
| Krueger | S580-5FF |

RHD- Fixed 45° Louver Return with Opposed Blade Damper

Aluminum Construction
Opposed Blade Damper
Surface Mount Border 1
White Finish

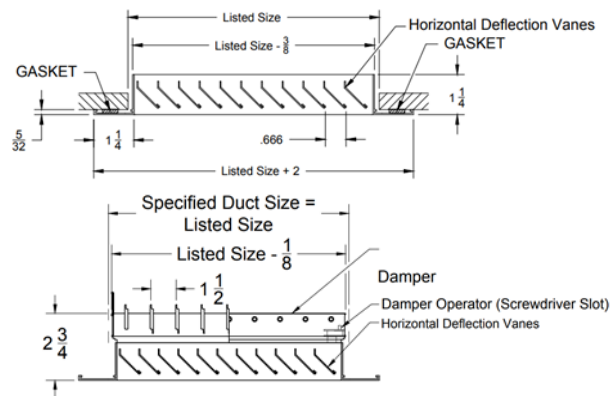
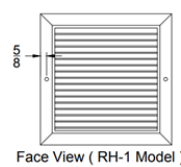
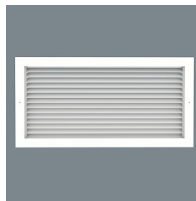

| Cross Reference | |
|-----------------|-------|
| Brand | Model |
| Titus | 350FL |
| Price | 630 |
| Nailor | 5145H |
| Krueger | S580 |

| RHD-Fixed Louver Return with Damper | | | |
|-------------------------------------|-----------|-----------|--|
| Model | Neck | Face | |
| GHXGRH1 06x06 01 OBDA | 06" x 06" | 08" x 08" | |
| GHXGRH1 08x08 01 OBDA | 08" x 08" | 10" x 10" | |
| GHXGRH1 10x10 01 OBDA | 10" x 10" | 12" x 12" | |
| GHXGRH1 12x12 01 OBDA | 12" x 12" | 14" x 14" | |
| GHXGRH1 14x14 01 OBDA | 14" x 14" | 16" x 16" | |
| GHXGRH1 16x16 01 OBDA | 16" x 16" | 18" x 18" | |
| GHXGRH1 18x18 01 OBDA | 18" x 18" | 20" x 20" | |
| GHXGRH1 20x20 01 OBDA | 20" x 20" | 22" x 22" | |



Roto-Twist Cable Damper-Internal Mounted

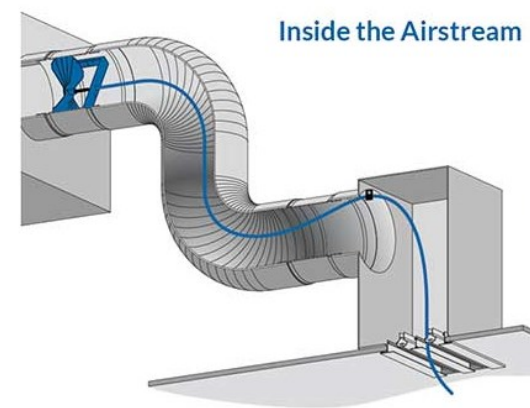

Radial Damper
Internal Mounting
6' Operating Cable

| RT-150 ROUND DAMPER | |
|---------------------|------|
| Model | Size |
| MATRT615006 | 06" |
| MATRT615008 | 08" |
| MATRT615010 | 10" |
| MATRT615012 | 12" |
| MATRT615014 | 14" |

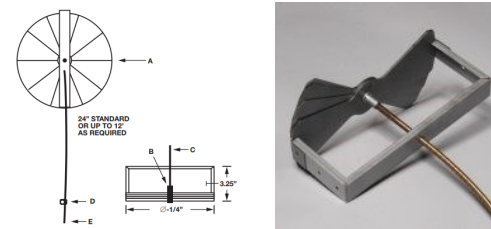

| Accessories | |
|-------------|----------------------------|
| Model | Description |
| MATA04 | 4' Cable |
| MATA08 | 8' Cable |
| MAT1027 | Square to Square Coupling |
| MAT1012 | Square to Round Coupling |
| MAT1048 | Field Cut Cable End Square |
| MAT1014 | 1/4" Nut Driver |



Roto-Twist Cable Damper-External Mounted

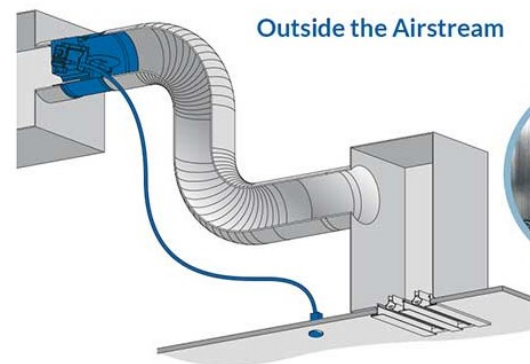

Radial Damper
External Mounting
10' Operating Cable
Worm Gear Driver

| RT-250 Damper Only | |
|--------------------|------|
| Model | Size |
| MATRT25006 | 06" |
| MATRT25008 | 08" |
| MATRT25010 | 10" |
| MATRT25012 | 12" |
| MATRT25014 | 14" |

| Accessories—Operator and Termination | |
|--------------------------------------|---|
| Model | Size |
| MATRTCCM | Worm Gear, 10' Cable, 1" Mini-CUP Termination |

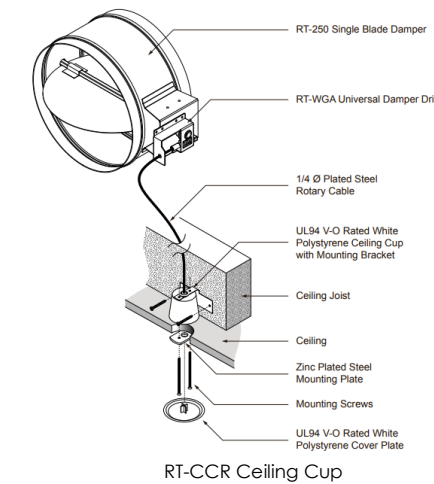
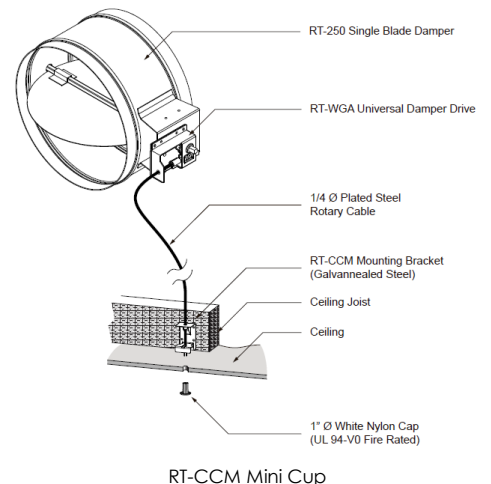
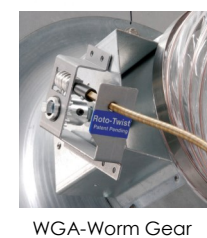

DALLAS
10350 Olympic Drive
Dallas, TX 75220
800.539.4633 Toll Free
214.350.6871 Main Line

FORT WORTH
2901 Wesley Way
Fort Worth, TX 76118
800.858.8497 Toll Free
682.253.0122 Main Line



DALLAS
10350 Olympic Drive
Dallas, TX 75220
800.539.4633 Toll Free
214.350.6871 Main Line

FORT WORTH
2901 Wesley Way
Fort Worth, TX 76118
800.858.8497 Toll Free
682.253.0122 Main Line



Square to Round Adapter's

Steel Construction
Mill Finish

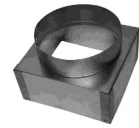

DMSR- Square to Round Adapters

| Model | Connection | Inlet |
|----------|------------|-------|
| DMSR0604 | 06" x 06" | 04" |
| DMSR0606 | 06" x 06" | 06" |
| DMSR0806 | 08" x 08" | 06" |
| DMSR0808 | 08" x 08" | 08" |
| DMSR0906 | 09" x 09" | 06" |
| DMSR0908 | 09" x 09" | 08" |
| DMSR0909 | 09" x 09" | 09" |
| DMSR1006 | 10" x 10" | 06" |
| DMSR1008 | 10" x 10" | 08" |
| DMSR1010 | 10" x 10" | 10" |
| DMSR1206 | 12" x 12" | 06" |
| DMSR1208 | 12" x 12" | 08" |
| DMSR1209 | 12" x 12" | 09" |
| DMSR1210 | 12" x 12" | 10" |
| DMSR1212 | 12" x 12" | 12" |
| DMSR1408 | 14" x 14" | 08" |
| DMSR1410 | 14" x 14" | 10" |
| DMSR1412 | 14" x 14" | 12" |
| DMSR1414 | 14" x 14" | 14" |
| DMSR1506 | 15" x 15" | 06" |
| DMSR1508 | 15" x 15" | 08" |
| DMSR1510 | 15" x 15" | 10" |
| DMSR1512 | 15" x 15" | 12" |
| DMSR1514 | 15" x 15" | 14" |
| DMSR1610 | 16" x 16" | 10" |
| DMSR1612 | 16" x 16" | 12" |
| DMSR1614 | 16" x 16" | 14" |
| DMSR1616 | 16" x 16" | 16" |

DMSR- Square to Round Adapters

| Model | Connection | Inlet |
|-------------|------------|-------|
| DMSR1808 | 18" x 18" | 08" |
| DMSR1810 | 18" x 18" | 10" |
| DMSR1812 | 18" x 18" | 12" |
| DMSR1814 | 18" x 18" | 14" |
| DMSR1816 | 18" x 18" | 16" |
| DMSR1818 | 18" x 18" | 18" |
| DMSR2008 | 20" x 20" | 08" |
| DMSR2010 | 20" x 20" | 10" |
| DMSR2012 | 20" x 20" | 12" |
| DMSR2014 | 20" x 20" | 14" |
| DMSR2016 | 20" x 20" | 16" |
| DMSR2018 | 20" x 20" | 18" |
| DMSR2206 | 22" x 22" | 06" |
| DMSR2208 | 22" x 22" | 08" |
| DMSR2210 | 22" x 22" | 10" |
| DMSR2212 | 22" x 22" | 12" |
| DMSR2214 | 22" x 22" | 14" |
| DMSR2216 | 22" x 22" | 16" |
| DMSR2218 | 22" x 22" | 18" |
| DMSR2220 | 22" x 22" | 20" |
| DMRTR221006 | 22" x 10" | 06" |
| DMRTR221008 | 22" x 10" | 08" |
| DMRTR221010 | 22" x 10" | 10" |

Round Control Damper's

Single Blade Damper
Galvanized Steel

VCDR- Round Damper

| Model | Size |
|------------|------|
| GHVCDR5006 | 06" |
| GHVCDR5008 | 08" |
| GHVCDR5010 | 10" |
| GHVCDR5012 | 12" |

Ratings

Pressure: Up to 4 in. wg (1 kPa) - pressure differential
Velocity: Up to 3,000 fpm (15.2 m/s)
Temperature: Up to 250°F (121°C)



Round Control Damper



Diameter dimension furnished approximately 1/8 in. (3mm) undersize.

Frame Length

Diameter <= 14 in. (356mm), frame length is 8 1/8 in. (206mm).
Diameter >14 in. (356mm), frame length is 11 1/8 in. (296mm)

DALLAS
10350 Olympic Drive
Dallas, TX 75220
800.539.4633 Toll Free
214.350.6871 Main Line

FORT WORTH
2901 Wesley Way
Fort Worth, TX 76118
800.858.8497 Toll Free
682.253.0122 Main Line



RH- Fixed 45° Louver Return

Aluminum Construction
Surface Mount Border 1
White Finish

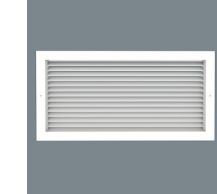
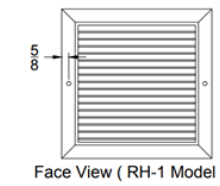
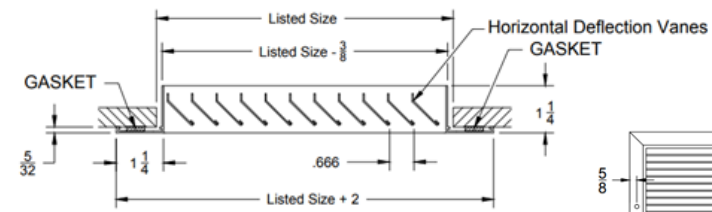

RH-Aluminum Fixed Return

| Model | Neck | Face |
|------------------|-----------|-----------|
| GHXGRH1 08x06 01 | 08" x 06" | 10" x 08" |
| GHXGRH1 10x06 01 | 10" x 06" | 12" x 08" |
| GHXGRH1 10x08 01 | 10" x 08" | 12" x 10" |
| GHXGRH1 12x06 01 | 12" x 06" | 14" x 08" |
| GHXGRH1 12x08 01 | 12" x 08" | 14" x 10" |
| GHXGRH1 12x10 01 | 12" x 10" | 14" x 12" |
| GHXGRH1 14x06 01 | 14" x 06" | 16" x 08" |
| GHXGRH1 14x08 01 | 14" x 08" | 16" x 10" |
| GHXGRH1 14x10 01 | 14" x 10" | 16" x 12" |
| GHXGRH1 14x12 01 | 14" x 12" | 16" x 14" |
| GHXGRH1 16x06 01 | 16" x 06" | 18" x 08" |
| GHXGRH1 16x08 01 | 16" x 08" | 18" x 10" |
| GHXGRH1 16x10 01 | 16" x 10" | 18" x 12" |
| GHXGRH1 16x12 01 | 16" x 12" | 18" x 14" |
| GHXGRH1 18x06 01 | 18" x 06" | 20" x 08" |
| GHXGRH1 18x08 01 | 18" x 08" | 20" x 10" |
| GHXGRH1 18x10 01 | 18" x 10" | 20" x 12" |
| GHXGRH1 18x12 01 | 18" x 12" | 20" x 14" |
| GHXGRH1 18x14 01 | 18" x 14" | 20" x 16" |
| GHXGRH1 20x06 01 | 20" x 06" | 22" x 08" |
| GHXGRH1 20x08 01 | 20" x 08" | 22" x 10" |
| GHXGRH1 20x10 01 | 20" x 10" | 22" x 12" |
| GHXGRH1 20x12 01 | 20" x 12" | 22" x 14" |
| GHXGRH1 20x14 01 | 20" x 14" | 22" x 16" |
| GHXGRH1 20x16 01 | 20" x 16" | 22" x 18" |
| GHXGRH1 22x06 01 | 22" x 06" | 24" x 08" |
| GHXGRH1 22x08 01 | 22" x 08" | 24" x 10" |
| GHXGRH1 22x10 01 | 22" x 10" | 24" x 12" |
| GHXGRH1 22x12 01 | 22" x 12" | 24" x 14" |
| GHXGRH1 22x14 01 | 22" x 14" | 24" x 16" |
| GHXGRH1 22x16 01 | 22" x 16" | 24" x 18" |
| GHXGRH1 22x18 (| 22" x 18" | 24" x 20" |

RH-Aluminum Fixed Return

| Model | Neck | Face |
|------------------|-----------|-----------|
| GHXGRH1 24x06 01 | 24" x 06" | 26" x 08" |
| GHXGRH1 24x08 01 | 24" x 08" | 26" x 10" |
| GHXGRH1 24x10 01 | 24" x 10" | 26" x 12" |
| GHXGRH1 24x12 01 | 24" x 12" | 26" x 14" |
| GHXGRH1 24x14 01 | 24" x 14" | 26" x 16" |
| GHXGRH1 24x16 01 | 24" x 16" | 26" x 18" |
| GHXGRH1 24x18 01 | 24" x 18" | 26" x 20" |
| GHXGRH1 24x20 01 | 24" x 20" | 26" x 22" |
| GHXGRH1 24x24 01 | 24" x 22" | 26" x 24" |
| GHXGRH1 26x08 01 | 26" x 08" | 28" x 10" |
| GHXGRH1 26x10 01 | 26" x 08" | 28" x 10" |
| GHXGRH1 26x12 01 | 26" x 10" | 28" x 12" |
| GHXGRH1 26x14 01 | 26" x 12" | 28" x 14" |
| GHXGRH1 26x16 01 | 26" x 14" | 28" x 16" |
| GHXGRH1 26x18 01 | 26" x 16" | 28" x 18" |
| GHXGRH1 26x20 01 | 26" x 18" | 28" x 20" |
| GHXGRH1 28x10 01 | 26" x 20" | 28" x 22" |
| GHXGRH1 28x12 01 | 28" x 10" | 30" x 12" |
| GHXGRH1 28x14 01 | 28" x 14" | 30" x 16" |
| GHXGRH1 28x16 01 | 28" x 16" | 30" x 18" |
| GHXGRH1 28x18 01 | 28" x 18" | 30" x 20" |
| GHXGRH1 28x20 01 | 28" x 20" | 30" x 22" |
| GHXGRH1 30x12 01 | 30" x 12" | 32" x 14" |
| GHXGRH1 30x14 01 | 30" x 14" | 32" x 16" |
| GHXGRH1 30x16 01 | 30" x 16" | 32" x 18" |
| GHXGRH1 30x18 01 | 30" x 18" | 32" x 20" |
| GHXGRH1 30x20 01 | 30" x 20" | 32" x 22" |
| GHXGRH1 30x30 01 | 30" x 30" | 32" x 32" |

Cross Reference

| Brand | Model |
|---------|-------|
| Titus | 350FL |
| Price | 630 |
| Nailor | 5145H |
| Krueger | S580 |

DALLAS
10350 Olympic Drive
Dallas, TX 75220
800.539.4633 Toll Free
214.350.6871 Main Line

FORT WORTH
2901 Wesley Way
Fort Worth, TX 76118
800.858.8497 Toll Free
682.253.0122 Main Line



BDS- Steel Butterfly Damper

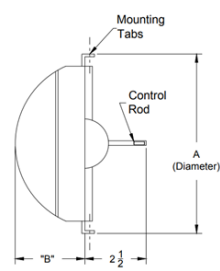
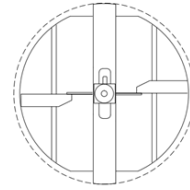

| BDS- Butterfly Damper | |
|-----------------------|------|
| Model | Size |
| GHXGBDS06 24 | 06" |
| GHXGBDS08 24 | 08" |
| GHXGBDS10 24 | 10" |
| GHXGBDS12 24 | 12" |
| GHXGBDS14 24 | 14" |

5DA- Aluminum Opposed Blade Damper (5500 Series Only)

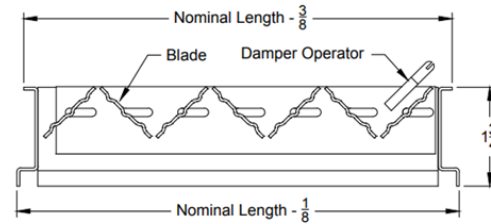

| 5DA- Opposed Blade Damper | | |
|---------------------------|-----------|--|
| Model | Size | |
| GHXGD5A 06x06 24 | 06" x 06" | |
| GHXGD5A 09x09 24 | 09" x 09" | |
| GHXGD5A 12x12 24 | 12" x 12" | |
| GHXGD5A 15x15 24 | 15" x 15" | |
| GHXGD5A 18x18 24 | 18" x 18" | |

OBDA- Aluminum Opposed Blade

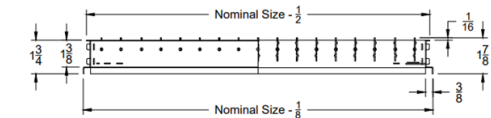

| OBDA Opposed Blade Damper | | |
|---------------------------|-----------|--|
| Model | Size | |
| GHXGOBDA 10x10 24 | 10" x 10" | |
| GHXGOBDA 22x10 24 | 22" x 10" | |
| GHXGOBDA 22x22 24 | 22" x 22" | |

ROD-Face Operable Damper

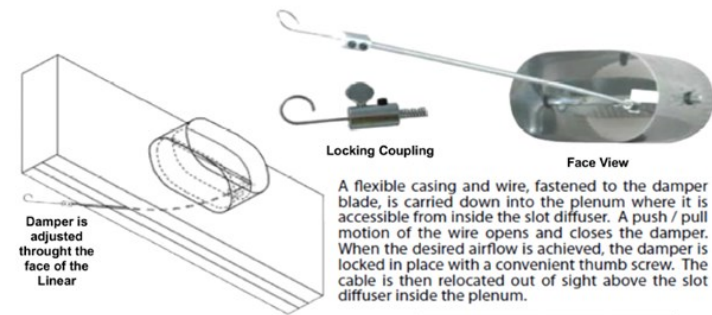

| Size | Type | A | B |
|------|-------|--------|----------|
| 06" | Round | 5 7/8" | |
| 08" | Oval | 5 7/8" | 8 15/16" |
| 10" | Oval | 5 7/8" | 12 1/16" |
| 12" | Oval | 5 7/8" | 15 1/4" |

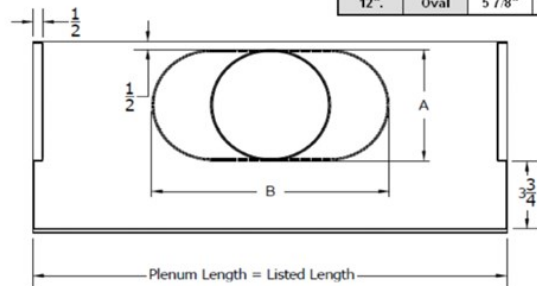

| ROD Face Operable Damper | |
|--------------------------|-----------|
| Model | Size |
| GHXGROD06 | 06" ROUND |
| GHXGROD08 | 08" OVAL |
| GHXGROD10 | 10" OVAL |
| GHXGROD12 | 12" OVAL |

DALLAS
10350 Olympic Drive
Dallas, TX 75220
800.539.4633 Toll Free
214.350.6871 Main Line

FORT WORTH
2901 Wesley Way
Fort Worth, TX 76118
800.858.8497 Toll Free
682.253.0122 Main Line



RSD- Steel Radial Damper

| RSD-Radial Damper | |
|-------------------|------|
| Model | Size |
| GHXGRSD 06 24 | 06" |
| GHXGRSD 08 24 | 08" |
| GHXGRSD 10 24 | 10" |
| GHXGRSD 12 24 | 12" |

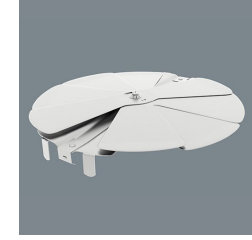
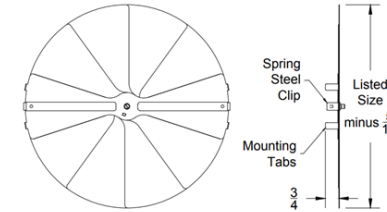

| TBPF-Trim Frames | | |
|-------------------|-----------|---------------------|
| Model | Nominal | Overall |
| GHXGTBPF 12 01 | 12" x 12" | 13-3/16" x 13-3/16" |
| TBSMF2020 | 18" X 18" | 21-1/2" x 21-1/2" |
| GHXGTBPF 24/12 01 | 24" x 12" | 25-3/16" x 13-3/16" |
| GHXGTBPF 24 01 | 24" X 24" | 25-3/16" x 25-3/16" |
| GHXGTBPF 48/24 01 | 48" x 24" | 49-3/16" x 25-3/16" |

TBPF- Trim Frames

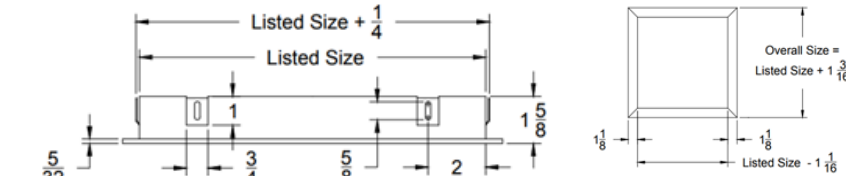
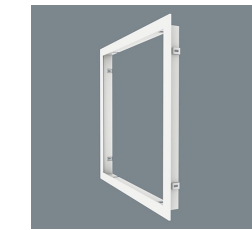

| Miscellaneous Accessories | | |
|---------------------------|-----------|---------------------------|
| Model | Size | Description |
| GHXGFGBP24 | 24" x 24" | Molded Insulation Blanket |
| GHXGBAF1 01 | | Sectorizing Baffle |
| GHXGPAINT WHITE | - | Touch-Up Paint |
| GHXGPAINT BLACK | - | Touch-Up Paint |

Miscellaneous Accessories

DMRR-Round to Round Adapter

| DMRR- Round to Round Adapters | | |
|-------------------------------|-------|--------|
| Model | Inlet | Outlet |
| DMRR0604 | 06" | 04" |
| DMRR0605 | 06" | 05" |
| DMRR0806 | 08" | 06" |
| DMRR0807 | 08" | 07" |
| DMRR1008 | 10" | 08" |
| DMRR1009 | 10" | 09" |
| DMRR1210 | 12" | 10" |
| DMRR1412 | 14" | 12" |
| DMRR1514 | 15" | 14" |
| DMRR1516R | 15" | 16" |

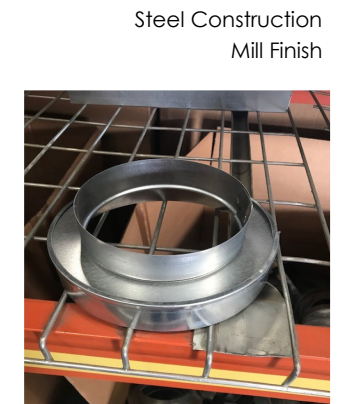

DALLAS
10350 Olympic Drive
Dallas, TX 75220
800.539.4633 Toll Free
214.350.6871 Main Line

FORT WORTH
2901 Wesley Way
Fort Worth, TX 76118
800.858.8497 Toll Free
682.253.0122 Main Line

